

---

---

# ALINCO

COMMUNICATIONS RECEIVER

# DX-R8T/E

## Instruction Manual

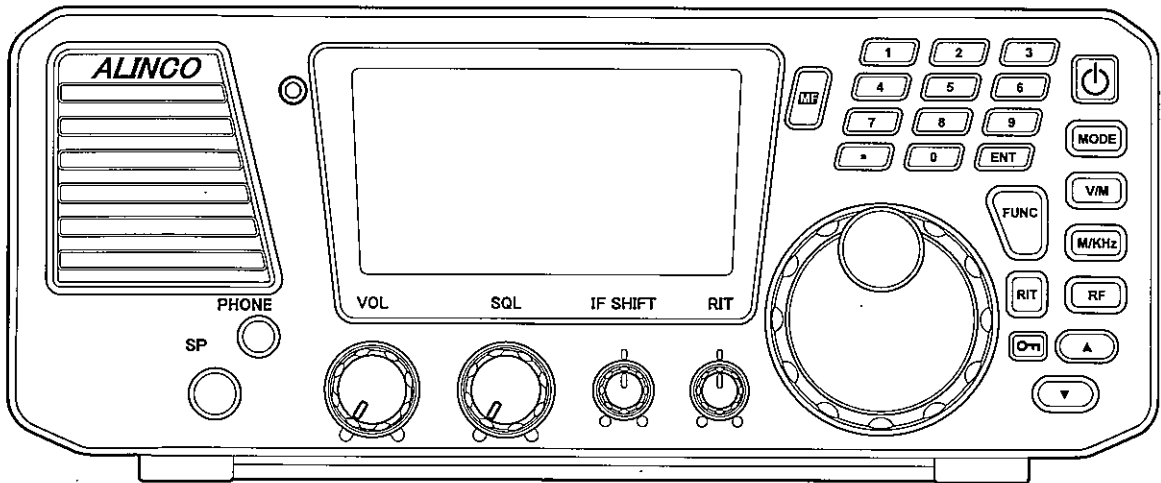

Thank you for purchasing your new ALINCO receiver.

This instruction manual (and addendum sheets) contains important safety and operating instructions.

Please read this manual carefully before using the product and keep it for future reference.

# NOTICE / Compliance Information Statement

## Conformity Information

Alinco, Inc. Electronics Division hereby declares on our sole responsibility that the product(s) listed below comply with the essential requirements of the Directive 1999/5/EC, The council of 3/9/99 on Radio Equipment and Telecommunication Terminal Equipment and the mutual recognition of their conformity and with the provisions of Annex, after having performed the required measurements at Notified Bodies per Standards, and relative certificate(s) or document(s) can be reviewed at <http://www.alinco.com/Ce/>.

**DX-SR8E**

LW/MW/SW ALL MODE RECEIVER



This device is authorized for use in all EU and EFTA member states.



Check with your local waste officials for details on recycling or proper disposal in your area.

**RoHS**

Below - 30MHz Receiver DX-R8T

The FCC Part 15 approval is not required for use of this device in USA/Canada.

Copyright © All rights reserved. No part of this document may be reproduced, translated or transcribed in any form or by any means without the prior permission of Alinco, Inc., Osaka, Japan, English Edition Printed in Japan.



Microsoft and Windows are trademarks, or registered trademarks of Microsoft Corporation in the United States and/or other countries.



Other names and brands are trademarks owned by its proprietor.

# WARNING

---









To prevent any hazard during operation of Alinco's radio product, in this manual and on the product you may find symbols shown below. Please read and understand the meanings of these symbols before starting to use the product.



 Danger	This symbol is intended to alert the user to an immediate danger that may cause loss of life and property if the user disregards the warning.
 Alert	This symbol is intended to alert the user to a possible hazard that may cause loss of life and property if the user disregards the warning.
 Caution	This symbol is intended to alert the user a possible hazard that may cause loss of property or injure the user if the warning is disregarded.

	Alert symbol. An explanation is given.
	Warning symbol. An explanation is given.
	Instruction symbol. An explanation is given.





## ALERT

### ■ Environment and condition of use:







-  Do not drive while handling the radio for your safety. It is recommended that you check local traffic regulations regarding the use of radio equipment while driving. Some countries prohibit the operation of radio equipment while driving.
-  Do not use this product in close proximity to other electronics devices, especially medical ones. It may cause interference to those devices.
-  Keep the radio out of the reach of children.
-  In case a liquid leaks from the product, do not touch it. It may damage your skin. Rinse with plenty of cold water if the liquid contacted your skin.
-  Never operate this product in facilities where radio products are prohibited for use such as aboard aircraft, in airports, in ports, within or near the operating area of business wireless stations or their relay stations.
-  Use of this product may be prohibited or illegal outside of your country. Be informed in advance when you travel.
-  The manufacturer declines any responsibilities against loss of life and/or property due to a failure of this product when used to perform important tasks like life-guarding, surveillance, and rescue.
-  Do not use multiple radios in very close proximity. It may cause interference and/or damage to the product(s).

-  The manufacturer declines any responsibilities against loss of life and property due to a failure of this product when used with or as a part of a device made by third parties.
-  Use of third party accessory may result in damage to this product. It will void our warranty for repair.

■ **Handling this product:**

-  Be sure to reduce the audio output level to minimum before using an earphone or a headset. Excessive audio may damage hearing.
-  Do not open the unit without permission or instruction from the manufacturer. Unauthorized modification or repair may result in electric shock, fire and/or malfunction.
-  Do not operate this product in a wet place such as shower room. It may result in electric shock, fire, electric and/or malfunction.
-  Do not place the product in a container carrying conductive materials, such as water or metal in close proximity to the product. A short-circuit to the product may result in electric shock, fire and/or malfunction.
-  Do not touch the heatsink (on/around the unit mostly found on mobile-base units) as it may become very hot during/after the operation that may risk burn your skin.

■ **About power-supply:**

-  Use only appropriate, reliable power supply of correct voltage and capacity.
-  Do not connect cables in reverse polarity. It may result in electric shock, fire and/or malfunction.
-  Do not plug multiple devices including the power-supply into a single wall outlet. It may result in overheating and/or fire.
-  Do not handle a power-supply with a wet hand. It may result in electric shock.
-  Securely plug the power-supply to the wall outlet. Insecure installation may result in short-circuit, electronic shock and/or fire.
-  Do not plug the power-supply into the wall socket if the contacts are dirty. Shortcircuiting and/or overheating may result in fire., electric shock and/or damage to the product.
-  Do not modify or remove fuse-assembly from the DC-cable. It may result in fire, electric shock and/or damage to the product.

## In case of emergency:

In case of the following situation(s), please turn off the product, switch off the source of power, then remove or unplug the power-cord. Please contact your local dealer of this product for service and assistance. Do not use the product until the trouble is resolved. Do not try to troubleshoot the problem by yourself.

- When a strange sound, smoke and or strange odor comes out of the product.
- When the product is dropped or the case is broken or cracked.
- When a liquid penetrated inside.
- When a power-cord ( including DC-cables, AC-cables and adapters) is damaged.



For your safety, turn off then remove all related AC-lines to the product and its accessories from the wall outlet if a thunderstorm is likely.



Turn off the unit, remove the mobile antenna from its base and keep it in the vehicle if a thunderstorm is likely.

Please read cautions regarding the lightning-protection on page 3 also.

## ■ Maintenance



Do not open the unit and its accessories. Please consult with your local dealer of this product for service and assistance.



## CAUTION

### ■ Environment and condition of use:



Do not use the product in proximity to a TV or a radio. It may cause interference or receive interference.



Do not install in a humid, dusty or insufficiently ventilated place. It may result in electric shock, fire and/or malfunction.





Do not install in an unstable or vibrating position. It may result in electric shock, fire and/or malfunction when/if the product falls to the ground.







Do not install the product in proximity to a source of heat and humidity such as a heater or a stove. Avoid placing the unit in direct sunlight.

### ■ About Receiver

-  Do not connect devices other than specified ones to the jacks and ports on the product. It may result in damage to the devices.
-  Turn off and remove the power-source (AC cable, DC cable, battery, cigar-cable, charger adapter etc) from the product when the product is not in use for extended period of time or in case of maintenance.
-  Use a clean, dry cloth to wipe off dirt and condensation from the surface of the product. Never use thinner or benzene for cleaning.

### ■ About power-supply

-  Use only reliable power supply of specified DC output range and be mindful of the polarity of the cables and DC jack.
-  Always turn off the power supply when connecting or disconnecting the cables.
-  When using an external antenna, make sure that the antenna ground is not common with the ground of the power supply.
-  European users: When a receiver is powered from an external DC power source (adapter, power supply, cigar-plug etc), make sure that this power supply has approval to the level of IEC/EN 60950-1.

# Contents

---

<b>Before Operating the Receiver</b> .....	<b>7</b>
Attention.....	7
Notice to California resident users.....	7
The receiver has no protection against lightning.....	7
Limited Power Source.....	7
<b>Introduction</b> .....	<b>8</b>
<b>1. Getting Started</b> .....	<b>9</b>
1-1 Functions and Features.....	9
1-2 Standard Accessories.....	10
1-3 Installation and Connection Basics.....	11
1-4 Controls, Connectors, and Display.....	14
Front Panel.....	14
Keypad.....	15
Rear Panel.....	16
Display.....	17
Quick Reference for Control Keys.....	18
<b>2. Operation</b> .....	<b>19</b>
2-1 Reception Basics.....	19
Direct Frequency Entry with Keypad.....	21
Getting Familiar with Useful Functions.....	22
2-2 RTTY/Packet Operation (FAX/SSTV).....	24
2-3 IQ Signal Output.....	25
<b>3. Memory Channels</b> .....	<b>26</b>
3-1 Basics.....	26
Features.....	26
3-2 Storing Data in Memory Channels.....	27
3-3 Memory Mode Operation.....	28
3-4 Memory Channel Data Erasing.....	29
Erasing Data in a Selected Memory Channel.....	29
Erasing All Memory Channels (Memory reset).....	29
3-5 Memory to VFO Data Transfer.....	30
3-6 Channel Name (Alphanumeric) Registration Function.....	30
3-7 Quick Memory.....	32
<b>4. Scanning</b> .....	<b>33</b>
4-1 Basics.....	33
Scan Modes.....	33
Scanning Conditions.....	35
4-2 VFO Scan.....	36
4-3 Programmed Scan.....	36
4-4 Search Scan.....	37
4-5 Memory Scan.....	37
4-6 Skip-channel Setting.....	38
4-7 Priority Scan.....	39

<b>5. Other Functions.....</b>	<b>40</b>
5-1 Interference Reducers .....	40
IF SHIFT.....	40
Narrow Filter.....	41
CW BFO REVERSE.....	42
NB (Noise Blanker) .....	42
5-2 Other Useful Functions .....	43
RIT Function.....	43
$\pm\Delta f$ (Plus-Minus Delta F) Function .....	43
VFO A=B Function .....	44
MULTI FUNCTION Feature .....	45
DIAL LOCK Function.....	46
KEY LOCK Function .....	46
Dimmer.....	46
Beep Sound .....	47
Sleep .....	47
CABLE CLONE .....	48
<b>6. Parameter Setting Mode (Set mode).....</b>	<b>49</b>
Table of Setting Mode Parameters .....	49
To Use the Parameter Setting Mode .....	49
Menu 00. Setting Frequency Step with the [▲/▼] Keys .....	50
• SSB and CW Mode.....	50
• AM Mode .....	50
• FM Mode.....	50
• IQ Mode .....	51
Menu 01. Memory Overwrite Protection .....	51
Menu 02. Memory Frequency Access Protection .....	51
Menu 03. Timer Scan Setting.....	52
Menu 04. Search Range Setting for Search Scan .....	53
Menu 05. Memory Scan Skip Setting.....	53
Menu 06. Automatic USB/LSB Selection .....	54
Menu 07. Automatic AGC-S/AGC-F Selection.....	54
Menu 08. Sleep Time Setting.....	55
Menu 09. Automatic Power Off (APO) .....	55
Menu 10. [▲/▼] Keys Repeat Setting .....	56
Menu 11. FUNC Key Resume Timing Setting.....	56
Menu 12. RX Lamp Setting.....	56
Menu 13. CW Pitch Frequency Setting.....	57
Menu 14. AF Mute Setting .....	57
Menu 15. IQ Shift Setting.....	57
<b>7. Maintenance and Reference .....</b>	<b>58</b>
7-1 Reset.....	58
Procedure.....	58
7-2 Cleaning.....	58
7-3 Troubleshooting .....	59
<b>Appendix .....</b>	<b>60</b>
Options .....	60
About Mounting Bracket and Carrying Handle.....	60
<b>After-Sales Customer Services .....</b>	<b>61</b>
<b>Specifications .....</b>	<b>62</b>



# Before Operating the Receiver

---

## Attention

- Do not remove the case or touch the interior components. Tampering can cause equipment trouble.
- Do not use or keep the receiver where it is exposed to direct sunlight, dusty places, or near sources of heat.
- Keep the receiver away from TV's or other equipment when it interferes with reception.
- Turn the power off immediately if the receiver emits smoke or strange odors. Ensure the receiver is safe, then bring it to the nearest Alinco service center.



## Notice to California resident users

The product that comes with this manual is free from dangerous material such as lead and cadmium as per RoHS order of EU.

## The receiver has no protection against lightning.

The user is responsible for providing adequate protection if he uses the device at home and installs the antenna outdoor. Be aware that any outdoor antenna creates a direct path for lightning current (more than 10kA) to the receiver. This path exists whether the device is turned ON or OFF.

Any vehicle does not present a safe environment during lightning. This environment becomes much more dangerous if an outdoor antenna is installed on the car. Move the antenna and its cable into the car at the first sight of forthcoming thunderstorm and lightning.

## Limited Power Source

Please note that the receiver enclosure only provides mechanical protection for its internal parts; it will not contain a fire within the device if the fire starts under certain fault conditions. Alinco will not take responsibility for any fire hazard associated with powering the receiver or charging its batteries using a power source that does not belong to the limited power source in the meaning of EN60950-1.

# Introduction

---

Thank you very much for purchasing this excellent Alinco receiver. Our products are ranked among the finest in the world. This radio has been manufactured with state of the art technology and it has been tested carefully at our factory. It is designed to operate to your satisfaction for many years under normal use.

- Please read this manual completely to learn all the functions the product offers. We made every attempt to edit this manual to be as comprehensive and easy to understand as possible. It is important to note that some of the operations may be explained in relation to information in different chapters. By reading just one part of the manual, you may risk not understanding the complete explanation of the function.
- In case addendum sheets such as errata are included in the package, please read them and keep them together with this manual for your future reference.
- This product is manufactured and shipped under strict quality control procedures. However, if you find anything unusual about this product, contact your local dealer as soon as possible.
- Due to the large bandwidth capability of this product, there may be cases when you cannot receive radio signals and/or instances when you hear noise due to the inner spurious signals generated by the unit; these cases are not malfunctions.
- Information in this document is subject to change without notice or obligation.
- In case there are problems with this manual, such as missing pages, we will exchange it with a new one at no charge.

## [Expressions in this Manual]

The word "press" in this manual means pressing a key and immediately release it. Expressions related to "pressing and holding" in this manual have the meaning of pressing and holding the key until the described state happens.

# 1. Getting Started

---

## 1-1 Functions and Features

- **All mode receiver with IQ signal output**  
Covers in SSB, AM, FM, CW and IQ signal output for SDR operation.
- **General coverage**  
Covers 150 kHz to 35 MHz in all modes. (T-version up to 30 MHz)
- **Direct frequency input**  
Provided with numerical keys to input frequency directly without using the dial.
- **Front control unit separation with the optional EDS-17**  
Completely detachable front control panel with large LCD.
- **Front speaker**  
Powerful and clear audio with 2 W Audio Amplifier.
- **Front jacks**  
Connecting easily with an external speaker and headphones.
- **Versatile interference eliminators**  
The IF SHIFT function; Built-in audio filter as standard for CW; and RF attenuator, all effectively help to reject unwanted signals.
- **600 memory channels**  
A total of 600 channels can be registered in three banks: 200 channels per bank.  
Each stores mode, filter, AGC, attenuator (or pre-amp), noise-blanker settings and more.
- **Computer control**  
The DX-R8 can be controlled by a personal computer through the serial interface using a free SDR-software.  
Settings of frequency, mode, and other parameters can be controlled.  
(Optional PC interface cables required)

## 1-2 Standard Accessories

### Checking Accessories

Carefully unpack to make sure the following items are found in the package.

■ DX-R8T/E

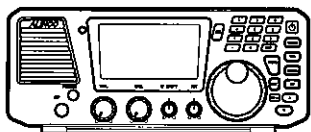

■ DC power cable (EDC-37)

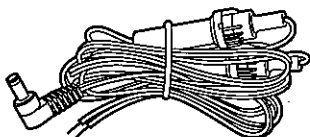

Includes 3A fuse

■ Instruction manual (PS0629)

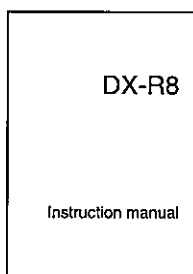

■ Warranty certificate

**Warranty Policy:**

Please refer to any enclosed warranty information or contact your authorized Alinco dealer/distributor for the warranty policy before purchase.

# 1-3 Installation and Connection Basics

## Connection Diagram

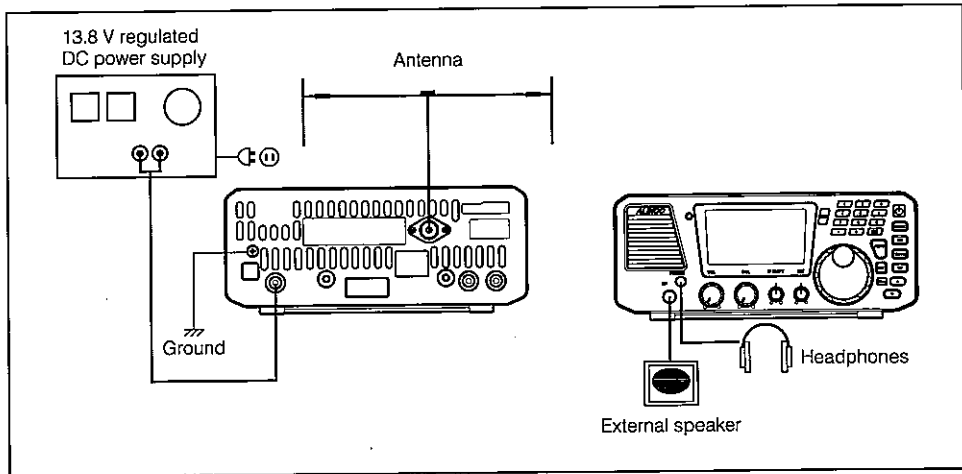

## Procedure

### 1. Connecting an antenna and ground cable

- Antenna connection

Use a properly-adjusted (low SWR) antenna to obtain optimum performance from the receiver. A 50 ohm impedance coaxial with PL-259 connector is required for this connection.

**NOTE:** It is recommended to use commercially available antenna tuner for proper antenna matching in case non-resonant antenna is connected.

- Ground connection

To prevent electric shock hazard and audio interference with other electronic appliances, bury a copper rod or plate under the ground and connect it to the transceiver GND terminal. Use a heavy gauge, short cable for this connection.

**IMPORTANT:** Do not ground the equipment on gas pipes, electrical conduits, or plastic water pipes.

## 2. Connecting an external speaker (if not using the internal speaker)

Connect a 3.5 mm diameter mono plug to the SPEAKER jack on the front panel. Use a 3 W or higher external speaker with 8 ohm impedance.

**NOTE:** When an external speaker is used, no sound is heard from the internal speaker.

### Caution information for when connecting an external speaker

When connecting an external speaker to the speaker jack on the front, use a 3.5 mm diameter stereo mini plug, connect the top of the plug so that the speaker and base are grounded as shown in the diagram below, and do not use the center pin. If a mono plug is used to connect, the clone jack on the rear panel will no longer be usable, and the ERW-7 and ERW-4C will no longer be able to be used.

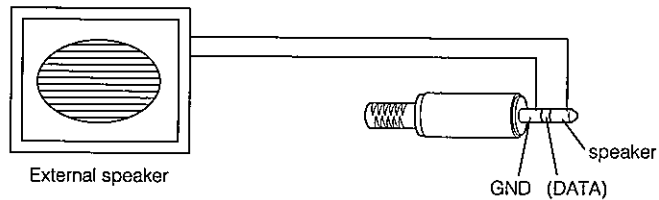

## 3. Connecting headphones

Connect a 3.5 mm diameter mono or stereo plug to the PHONES jack on the front panel.

**NOTE:** When headphones are used, no sound is heard from the speaker.

## 4. Connecting a regulated DC power supply

The Receiver requires a 12-13.8VDC negative grounded power source. Use a regulated power supply capable of providing continuous current of 3A or more. Power supplies that do not meet those specifications may cause malfunction and/or damage to the radio and will void the warranty.

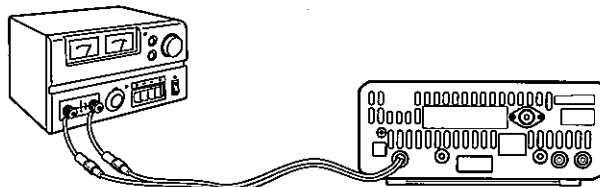

Connect red to '+', and black to '-'.

**IMPORTANT:** Before connecting, be sure to turn off the receiver and DC power supply.

\* When a receiver is powered from an external DC power source, make sure that this power supply has approval to the level of IEC/EN 60950-1.

## 5. Installing the control panel and body separately (optional)

**IMPORTANT:** Be sure to disconnect the power cable before carrying out this procedure.

1. Remove 2 screws above the main unit to separate the front-control panel. Disconnect the cable.
2. Remove other 2 screws at the bottom of the main unit.
3. Passing the separate-cable (5m) through the hole of the cover in advance, connect the cable to the main unit.

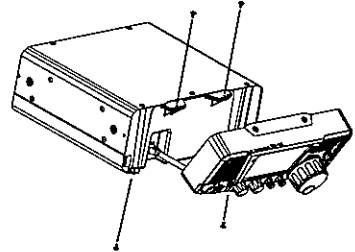

4. Fix the cover to the main unit using those 4 screws.

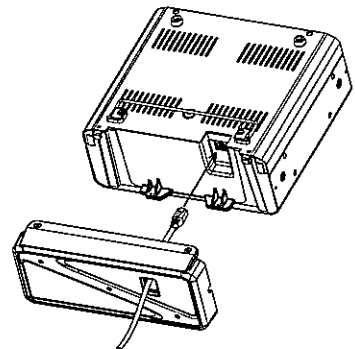

5. Fix the bracket using provided hardware, and connect another end of the cable to the front-control panel.

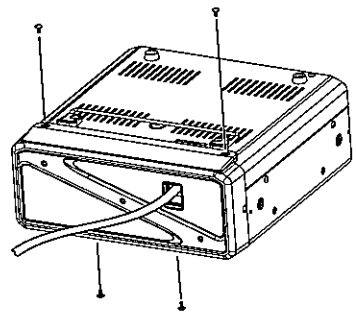

**NOTE:** Please be sure to keep the short, original cable in order to make it back to the original condition in future. Provided ferrite-beads on the separate cable are to eliminate the RF feed back. The position of beads may affect to the condition of RF feed back. See page 89 for troubleshooting.

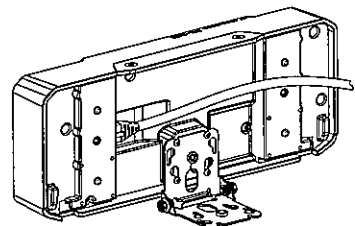

# 1-4 Controls, Connectors, and Display

## ■ Front Panel

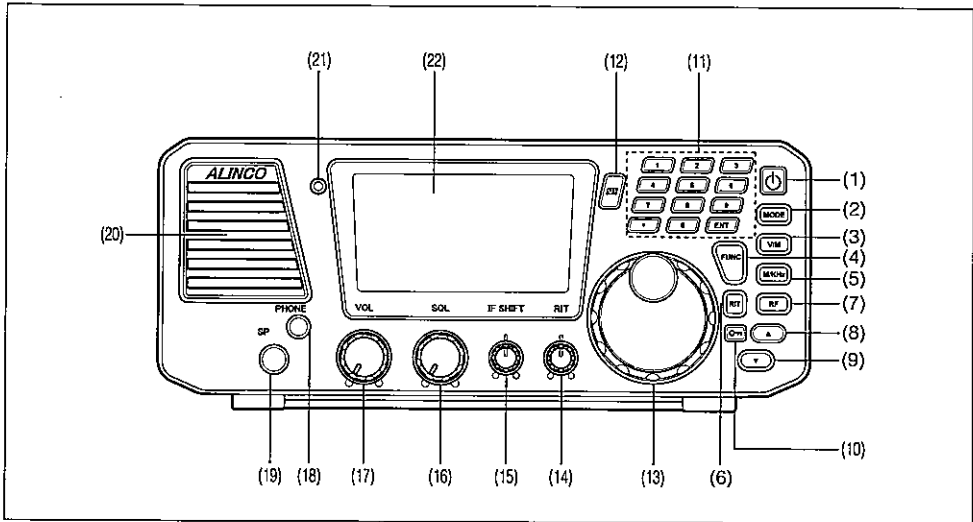

No.	Key	Principal Function
(1)	POWER SWITCH [  ]	Turns the power on/off.
(2)	[MODE] key	Press to select the USB, LSB, CWU, CWL, AM, FM or IQ modes.
(3)	[V/M] key	Switches between VFO mode and memory mode.
(4)	[FUNC] key	Press and hold this key for 1 second to access the Set mode.
(5)	[M/KHz] key	Switches the cursor position between MHz and kHz.
(6)	[RIT] key	Press to turn the RIT or TXIT function on/off.
(7)	[RF] key (preamplifier/attenuator)	Press to adjust receiver's front-end gain by switching between the preamplifier and attenuator. Pressing this key will change gains as follows: +10 dB, 0 dB, -10 dB, and -20 dB. After pressing the [FUNC] key, press this key to select a narrow filter in the SSB, CW and AM mode.
(8)	[▲] key	Press to select memory channels and to change frequency upward. Also used to select the receiver's settings in the Set mode.
(9)	[▼] key	Press to select memory channels and amateur radio bands, and to change frequency downward. Also used to select the receiver's settings in the Set mode.
(10)	[  ] key	Enables the dial and key locks.
(11)	KEYPAD	The keypad can be used for several functions as described later.
(12)	MULTI FUNC [MF] key	Press to access the multifunction.
(13)	MAIN tuning dial	Rotate to select receiving frequencies.
(14)	RIT control knob [RIT]	Fine-tunes the reception frequency within a range of $\pm 1.2$ kHz.
(15)	IF SHIFT control knob [IF SHIFT]	Rotate to eliminate the interference by shifting the receiver IF pass band ( $\pm 1.5$ kHz).
(16)	SQL control knob [SQL]	Rotate to eliminate noise when no signal is received.
(17)	AF gain control knob [VOL]	Rotate to adjust audio level.
(18)	PHONE jack [PHONE]	For connecting external headphones. Takes 8 to 32 ohm impedance headphones.
(19)	SPEAKER jack [SP]	For connecting an external speaker. Takes 8 to 16 ohm impedance speakers. Connect optional ERW-4C or ERW-7 cable for PC-interface.
(20)	Internal Speaker	Received signals are heard from here.
(21)	RX Lamp	Lights when signals are received or squelch is open. Default setting is off.
(22)	LCD Display	Shows operating and setting information.



## ■ Keypad

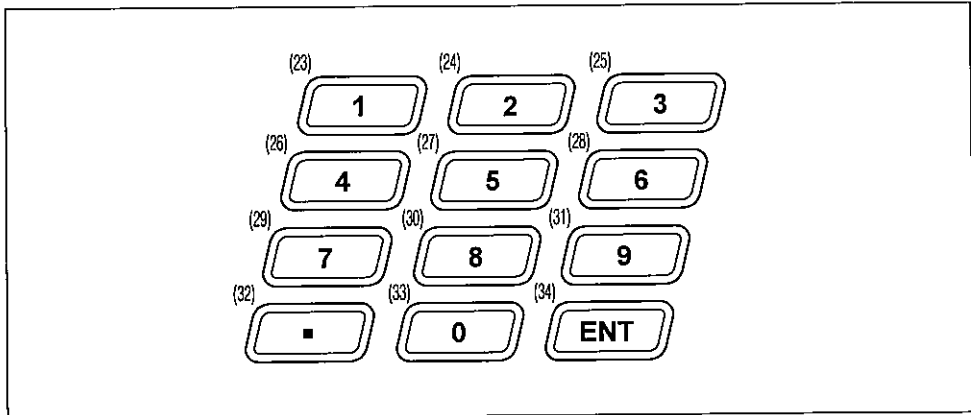

No.	Name	Function
(23)	1	Frequency direct input "1"
(24)	2	Frequency direct input "2"
(25)	3	Frequency direct input "3"
(26)	4	Frequency direct input "4"
(27)	5	Frequency direct input "5"
(28)	6	Frequency direct input "6"
(29)	7	Frequency direct input "7"
(30)	8	Frequency direct input "8"
(31)	9	Frequency direct input "9"
(32)	.	Direct input of a decimal point
(33)	0	Frequency direct input "0"
(34)	ENT	Enters a frequency direct input.

■ Rear Panel

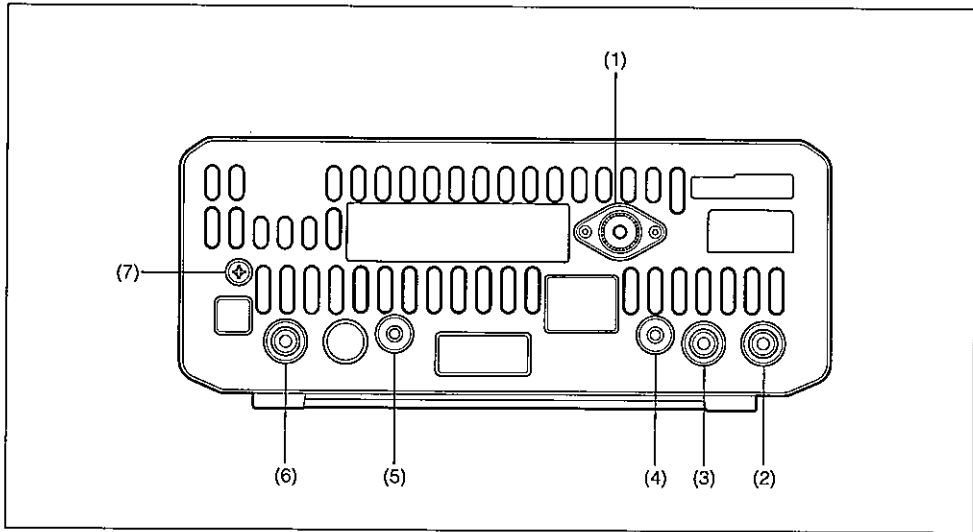

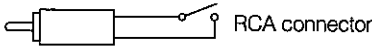
No.	Name	Function
(1)	Antenna connector	For connecting an antenna, takes a 50 ohm impedance coaxial cable with PL-259 connector.
(2)	MUTE jack	To mute the audio, make a simple switch circuit as shown (optional feature).  
(3)	AF jack	A detector signal output of approx. 50 mV. Use RCA connector.
(4)	CLONE jack	For connecting optional FRW-4C/ERW-7 to use utility and other software as a replacement to SP jack on the front panel.
(5)	IQ signal jack	This an IQ signal output jack. Connect a 3.5 mm stereo audio cable.
(6)	DC power connector	Connect the provided DC power cable to a power connector.
(7)	GND (ground) terminal	Connect the ground cable.

■ Display

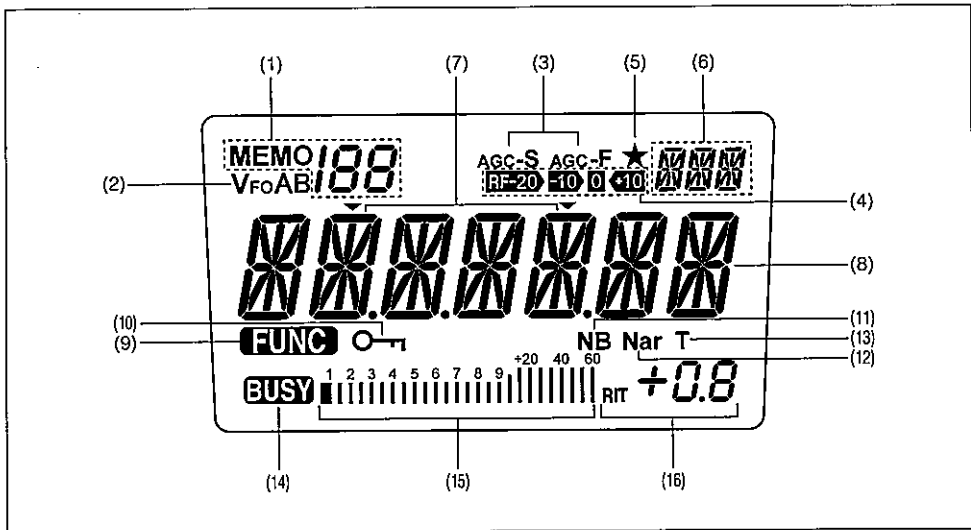

No.	Display	Function
(1)	<b>MEMO</b> 188	Appears in the MEMORY mode, indicating the selected memory channel.
(2)	<b>VfoAB</b>	Indicates the selected VFO mode A or B.
(3)	<b>AGC-S AGC-F</b>	AGC parameter, S for slow, F for fast. (not in FM mode)
(4)	<b>RF-20 -10 0 +10</b>	Indicates the receiver's front-end gain or attenuation level.
(5)	★	Appears when a Multi-function key is activated.
(6)	FM	Indicates the selected mode, including LSB, USB, CWL, CWU, FM, AM, IQ and SET.
(7)	▼	This cursor notifies of the position you can change using the [M/KHz] key. Appears above the frequency digit you can change with the [▲/▼] keys.
(8)	188.000	Indicates the receiving frequency.
(9)	<b>FUNC</b>	Appears when a function key is activated.
(10)	🔒	Appears when the DIAL or key LOCK function is activated.
(11)	<b>NB</b>	Appears when the NB (noise blanker) is activated.
(12)	<b>Nar</b>	Appears when the narrow filter is used in the SSB, CW and AM modes.
(13)	<b>T</b>	Appears during the sleep operation.
(14)	<b>BUSY</b>	Appears when squelch is unmuted.
(15)	1 2 3 4 5 6 7 8 9 +20 40 60	S meter: Indicates relative received signal strength.
(16)	<b>RIT</b> +0.8	Indicates the RIT shift frequency.

## ■ Quick Reference for Control Keys

There are 3 types of key operations; simply press it, press it after [FUNC] key, or press and hold it for more than 1 second (\*).

**NOTE:**       **FUNC + this key: Press [FUNC] key, then press this key.**  
**(P.xx) refers to the page this operation is mentioned in this manual.**

	This key only	FUNC + this key (See NOTE)
FUNC	Accesses the FUNC mode. * Accesses Parameter setting mode. (P.49)	-
V/M	Switches between VFO Mode and Memory Mode. * Activates VFO A = B function (P.44)	Switches to memory bank. * Program memory channels.
M/KHz	Changes cursor position for setting band/memory/frequency with [▲/▼] keys. (P.20)	Switches between AGC-S and AGC-F.
MODE	Selects the USB, LSB, CWU, CWL, AM, FM and IQ modes. * The mode UP/DOWN operation is available. (P.19)	Switches between UT, LT and IQ modes. (P.24)
RF	Changes RF gain. * Opens squelch. (P.22)	Switches between narrow filter ON/OFF. (P.42)
	Locks main dial tuning. (P.46)	Locks keys and main dial tuning. (P.46)
MF	Accesses the Multifunction. (P.45)	The allotment setting of the [MULTI] key.
▲	UP of MHz, kHz, BAND and Memory. * Changes automatically while the key is pressed.	
▼	DOWN of MHz, kHz, BAND and Memory. * Changes automatically while the key is pressed.	
RIT	Switches RIT function ON/OFF. (P.43)	±Δf function of RIT. (P.43)
1	Frequency direct input "1".	Switches between VFO A and VFO B. Switches between memories bank A, B and blank.
2	Frequency direct input "2".	Transfers memory to VFO. (P.30)
3	Frequency direct input "3".	Erases memory channel. (P.29)
4	Frequency direct input "4".	Starts the VFO or memory scan. (P.37)
5	Frequency direct input "5".	Starts the program scan. (P.36)
6	Frequency direct input "6".	Starts the search scan. (P.37)
7	Frequency direct input "7".	Turns the sleep function on and off. (P.47)
8	Frequency direct input "8".	Turns the priority function on and off. (P.39)
9	Frequency direct input "9".	NB (noise blanker) ON/OFF. (P.42)
0	Frequency direct input "0".	Turns the beep sound on and off. (P.47)
.	Direct input "decimal point".	Sets dimmer.
ENT	Enters a frequency direct input.	Alphanumeric name tag function. (Only In Memory Mode) (P.30)

# 2. Operation

## 2-1 Reception Basics

### 1. Turning the unit power on and off

**NOTE:** Make sure that all antenna and power connections are correct before turning the power on.

1. By pressing the [⏻] key the power turns on. By pressing the [⏻] key again, the power turns off.



### 2. Audio Volume level setting

- Turn the VOL knob clockwise to increase the audio volume.
- Turn the VOL counterclockwise to decrease the audio volume.

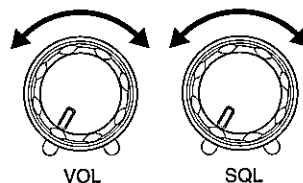

### 3. Squelch level setting

Adjust threshold level of the squelch. A squelch eliminates the background noise when a signal is not received.

1. Turn the SQL knob clockwise until white-noise (the background noise when a signal is not received) just disappears.
  - The SQL should be turned fully counterclockwise when receiving weak or unstable signals.

### 4. Selecting mode (modulation)

Press the [MODE] key to change the mode as below.

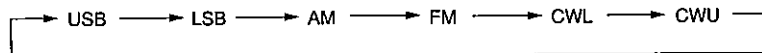

Hold down the [MODE] key more than 1 second to flash the displayed mode.

Select a mode by pressing the [▲/▼] keys.

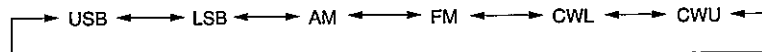

The flashing display stops at the next key operation.

- NOTE:**
- The SSB mode is most frequently used in HF bands. Usually, the LSB mode is used below 10 MHz amateur band, and the USB mode is used above 14 MHz amateur band.
  - The AM is commonly used to listen to MW and SW broadcasts.
  - The FM mode occupies a wide bandwidth: this will allow reproduction of high quality sound that is less affected by noise. The FM mode is hardly in use below 27 MHz.
  - The CW mode is used in Morse communications.
  - DX-R8 remembers the last used mode.

## 5. Setting the reception frequency

Various method is available to select receiving frequency in DX-R8. Let's start with a conventional way by using [▲/▼] keys.

- Each time the [M/KHz] key is pressed, ▼ shifts in the following manner:

- ▼ above MHz frequency indication.

Changes the 1 MHz digit.

- ▼ flashing above 1 kHz frequency indication.

Changes the 100 kHz digit.

- ▼ above kHz frequency indication.

Changes by minimum steps.

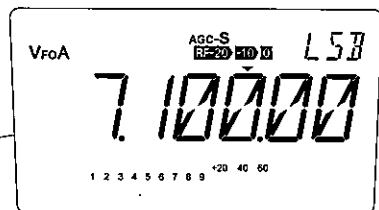
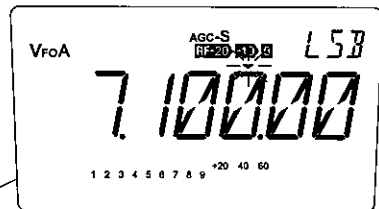
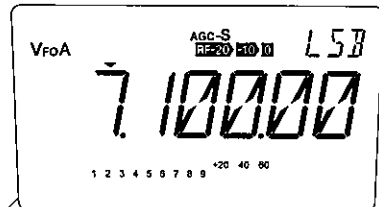

## 6. Tuning to a desired frequency

### Using VFO's

A VFO (variable frequency oscillator) is just like a tuning dial on a conventional radio. DX-R8 offers 2 VFOs, therefore you can set 2 different frequencies and switch between them as if you are operating 2 radios.

Press the [FUNC] key, then press the [1] key will switch between the VFO A and VFO B.

Select either VFO.

**NOTE:** DX-R8 has the VFO and MEMORY modes (see page 28). In the VFO mode, different frequencies and settings can be set in each individual VFO A and VFO B.

### Using the main tuning dial in VFO mode

- Turn the main tuning dial clockwise to increase the frequency.
- Turn the main tuning dial counterclockwise to decrease the frequency.

**NOTE:** In the SSB and CW modes, rotating the dial will change the frequency in 10 Hz steps (One full rotation will change frequency by 500 Hz). In the AM and FM modes, rotating the dial will change the frequency in 100 Hz steps (One full rotation will change frequency by 5 kHz).

### Using the [▲/▼] key

1. Move the cursor to desired position by pressing the [M/KHz] key.
2. Press the [▲] key to increase the frequency.

Press the [▼] key to decrease the frequency.

**NOTE:** • Frequency step is different by mode. The step can be selected in the set mode (see page 50, 51). The default is 0.1 kHz for SSB and CW, 1 kHz for AM, and 2.5 kHz for FM.

• In mobile operation, the selected frequency may be accidentally changed by the vibration, etc. To prevent this, use [O-] key for lock features. (see page 46)

In "dial-lock" status, tuning is still possible with the [▲/▼] key and RIT control knob.

## Direct Frequency Entry with Keypad

DX-R8 has a keypad for direct frequency entry as described below.

1. Press the numeral keys on the keypad to enter the MHz digits for the desired frequency.  
If a key is mistakenly pressed, press any key except numeral keys and start again from the beginning.
2. Press the [.] key on the keypad to separate MHz and kHz units.
3. Press the numeral keys to enter the frequency digits below 1 MHz.  
If a key is mistakenly pressed, press any key except numeral keys and start again from the beginning.
4. Press the [ENT] key to set the input frequency.  
When pressing the [ENT] key after entering the MHz digits, zeros are automatically entered for the kHz digits.  
\* When direct frequency entry with keypad, the mode does not change even if Automatic USB/LSB Selection is effective.

Example:

- To set to 21.035 MHz

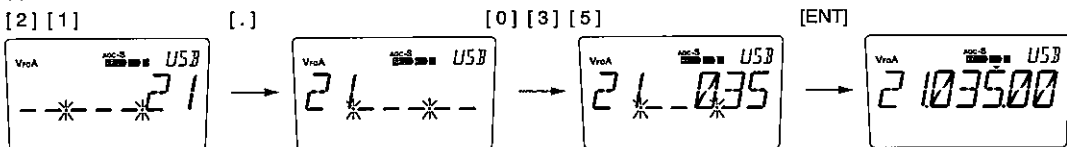

- To set to 705 kHz (0.705 MHz)

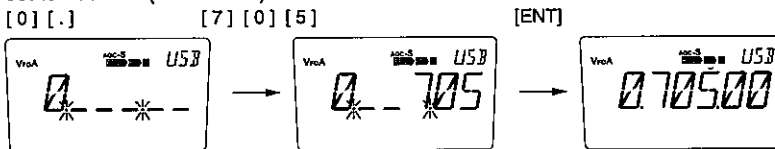

- To set to exactly 7 MHz

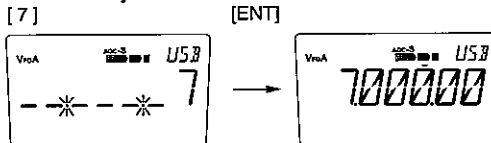

- To change 14.185 MHz to 14.750 MHz

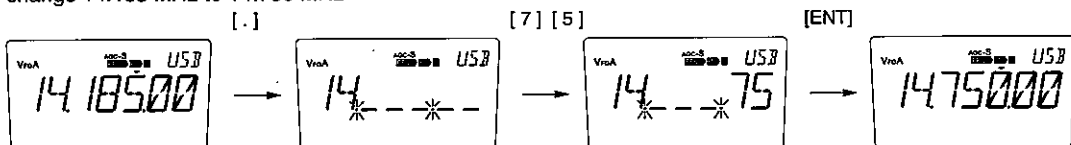

## Getting Familiar with Useful Functions

In LW/MW/SW bands, receive conditions vary not only with bands and modes but with time and season. To obtain optimum signal reception, get familiar with and take full advantage of these versatile functions.

### RF (RF gain)/ATT (attenuator)

1. Press the [RF] key to select one of the receiver's front-end gain settings.
  - Each time the [RF] key is pressed, the following icon will appear on the display:

**RF-20** **-10** **0** **<10** A 10 dB preamplifier is activated. This mode will be useful when receiving weak signals.

**RF-20** **-10** **0** This is the factory's default setting. Usually select this setting.

**RF-20** **-10** A 10 dB attenuator is activated. When receiving strong local signals, select this setting.

**RF-20** A 20 dB attenuator is activated. Select this setting when receiving very strong local signals or when you find such signals near the receiving signal.

**NOTE:**

- Use of preamplifier may result in intermodulation, heavier noise level, and other side-effects.
- In 10 dB attenuator position, a noise level may become slightly higher than the default position. This is due to the circuit design and not a defect.

### AGC (Automatic Gain Control)

The AGC function automatically adjusts the gain of strong signals and weak signals so that you can hear them at the similar level.

1. Press the [FUNC] key, then press the [M/KHz] key to select either the AGC-S or AGC-F mode.

**NOTE:** You may select either **AUTO** or **MANUAL** for the [FUNC] key operation. In Auto setting, FUNC status is automatically canceled if no key entry is performed within 5 seconds after the [FUNC] is displayed. Refer to the Menu 11 in the Set mode (page 56) for more details.

- AGC-S mode: The AGC recovery time is long, and suitable to SSB and AM modes.
- AGC-F mode: The AGC recovery time is short, and suitable to CW mode and data-signal reception such as FAX, RTTY and PSK.

**NOTE:** The AGC is automatically set to Fast in CW, Slow in SSB and AM modes. You can manually change from S to F or vice versa during operation but turning off the unit will reset the temporary setting. If you prefer to manually select the AGC setting always and wish that the setting remains regardless of power on/off, please select the OFF parameter in the Set mode menu 07 (P.54).



**RIT (Receiver Incremental Tuning)**

1. Press the [RIT] key. The "RIT" icon will appear on the LCD.

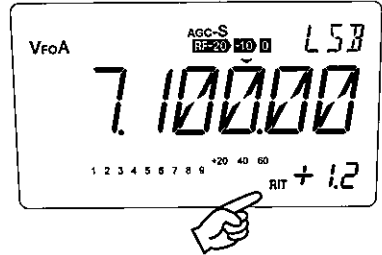

2. Rotate the RIT control knob to adjust the frequency.
  - \* To exit from the RIT function, press the [RIT] key repeatedly until both "RIT" icon disappears.
  - \* Press the [FUNC] key, then press the [RIT] key to add the RIT shift frequency to the operating frequency and exit from RIT operation.

## 2-2 RTTY/Packet Operation (FAX/SSTV)

DX-R8 has no dedicated features for RTTY packet, FAX, and SSTV receptions. However, these operations can be enabled by using the following procedures.

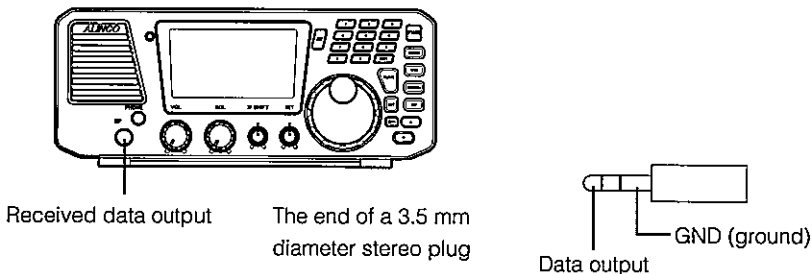

Speaker jack: For connecting a RECEIVE SIGNAL or AF-IN of, for example, an external modem.

### Procedure

1. Turn the power on.
2. Select the mode.
  - You may like to choose the mode UT (or LT) which gives a higher pitch passband, suited for data communications such as FAX, SSTV, RTTY, etc. To select UT or LT, press [FUNC] key and then [MODE] key in USB mode for UT, in LSB mode for LT. Press [FUNC] key and then [MODE] key again to go back to USB/LSB modes.
  - The change of UT/LT is automatic when AUTO is selected in Menu 06 (Page 54), it turns to UT for USB bands, LT for LSB bands.
3. Select the desired operating band.
4. Start receiving.

	Mode commonly used	DX-R8
RTTY (AFSK)	LSB	LT
AFSK (300 baud)	SSB	UT/LT
AFSK (1200 baud)	FM	FM
FAX	SSB/FM	UT/LT/FM
SSTV	SSB/FM	UT/LT/FM

**REFERENCE: Third-party-mode peripherals are available to ease data-mode operations. Please follow instructions of the devices as well in case you use them. Use of a PC and decoding software is another way to enjoy receiving data-signals.**

## 2-3 IQ Signal Output

The DX-R8 has an IQ signal output jack on the rear panel. If a commercially-available cable with a 3.5 mm diameter stereo mini plug on each end (this is the same cable as mentioned in the clone function section on page 48) is used to connect the IQ jack to a computer's Line-in jack, you will be able to use software that are available on the internet, such as SDR, FAX, RTTY, SSTV decoders and HFDDL.



Commercially available 3.5 mm  $\phi$  stereo mini plug audio cable.

1. Press the [MODE] key to select the FM mode.
2. Press [FUNC] key, then the [MODE] key. IQ appears on the display.
3. The same operation will return the mode setting to FM.



Sound does not come out of the DX-R8 when in IQ mode.



We have tested and checked the functioning of different software developed by third parties, but cannot guarantee that the software will function correctly as factors such as the program being used, computer compatibility, computer settings, and reception circumstances may have an influence on the software. Sorry, we can't answer questions about configuring DX-R8 with your PC and/or setting 3rd-party software.

# 3. Memory Channels

---

## 3-1 Basics

This receiver has three memory banks. 200 memory channels are available in each bank, for a total of 600 channels. Each can retain different operating data such as receive frequency mode, etc. It is convenient to store regularly monitoring frequencies in the memory and operate in the memory mode.

### Features

Each Memory channel including 00-199 and P1, P2 channel can store following parameters:

- Receiving frequency
- Mode (SSB, CW, FM, AM, etc.)
- Filter (standard/narrow, not applicable in the FM mode)
- RF (preamplifier/attenuator, not applicable in the FM mode)
- AGC (slow/fast, not applicable in the FM mode)
- Noise-blanker (ON/OFF, not applicable in the FM mode)
- Skip channel setting

### Functions in the MEMORY mode

- Memory frequency access protection (see page 51)
- Memory overwrite protection (see page 51)
- Memory-VFO transfer (see page 30)

**MEMO:** Some sample frequencies have been stored in factory.

**WWV=US Standard Frequency Station**

**NHK=NHK Radio Japan World Program in English**

**Aviation=HF aviation and VOLMET channels world-wide**

**Alinco does not guarantee the accuracy of broadcasting/communications frequencies as they are subject to change occasionally.**

## 3-2 Storing Data in Memory Channels

### Procedure

Example: Storing 7.050.00 MHz and LSB into memory channel "188" in bank A.

Please note that a symbol □ stands for "blank" bank and nothing appears on the display.

### Setting data

1. Set the data to be stored in VFO mode.

### Selecting a memory channel

2. Press the [FUNC] key. The memory number starts to flash.
3. Pressing [V/M] key switches the bank □ (blank), A and B, select the A bank.
4. Press the [▲/▼] keys to select memory channel "188". In this case, [▼] key works faster to select "188".  
An empty channel is shown with a flashing [Memory No.].

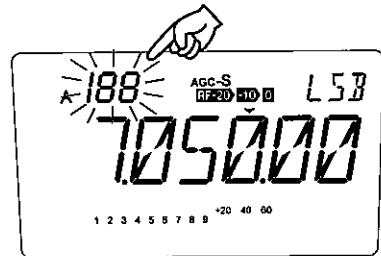

5. Press and hold the [V/M] key for more than 1 second while "FUNC" is on the display, a beep sounds, then flashing number disappears to complete the memory programming.
6. If a previously programmed channel is selected in step 4, the memory channel will be overwritten by executing the procedure in step 5.  
Read P.28 for memory operation.

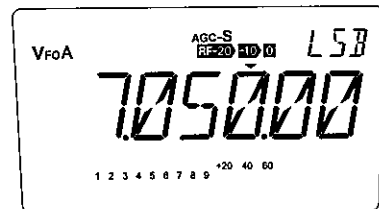

**NOTE:** To avoid overwriting, use overwrite protection in the Set mode menu 01, P.51.  
Use of the free utility software makes memory editing easy and convenient.  
Please visit [alinco.com](http://alinco.com) for details.

## 3-3 Memory Mode Operation

### Procedure

#### Accessing the Memory Mode

1. Press the [V/M] key to display the channel number and MEMO.  
The last-used memory channel will be recalled.

**NOTE:** Memory channel will not appear if nothing has been programmed in the memory.

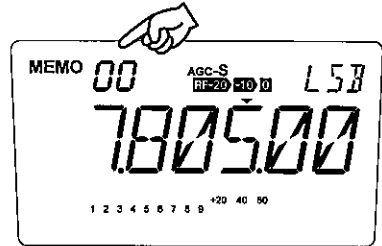

2. To select the bank, press [FUNC] then [1] key. Repeating this will switch between [Blank] → [A] → [B].

**NOTE:** Empty banks won't appear during this operation. Program at least 1 memory channel in each bank before performing this procedure.

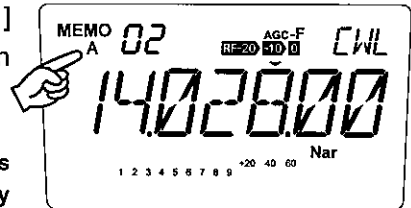

3. Press the [▲/▼] keys to select the desired memory channel.

**NOTE:**

- Empty channels will be skipped.
- In the Set mode, you can select either permitting the temporary change of parameters like mode, RIT etc. in memory or not. (page 51)

## 3-4 Memory Channel Data Erasing

### Erasing Data in a Selected Memory Channel

1. Press the [V/M] key to access the Memory mode.
2. Press the [▲/▼] keys or press [UP/DOWN] key of microphone to select a memory channel that you want to erase.

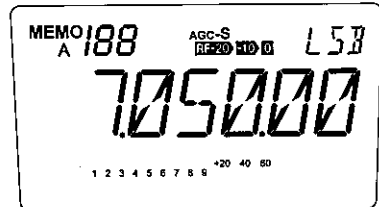

3. Press the [FUNC] key, then press the [3] key.  
The selected channel number flashes and completes the erase.

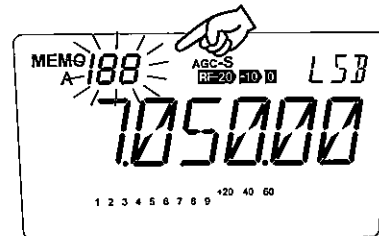

**NOTE:** Releasing the key will not affect the current LCD indication, but will erase the data in the selected memory channel.

### Erasing All Memory Channels (Memory reset)

1. Turn off the power.  
Turn on with [M/KHz] and [RF] keys pressed together to reset memory data only.

**REFERENCE:** See more details of available reset functions on page 58.

## 3-5 Memory to VFO Data Transfer

### Introduction

This function copies data from any memory channel to the VFO. This is useful when you wish to tune in a station near the frequency stored in a memory channel.

### Procedure

Example: Copying data in memory channel "06" into the VFO A

1. Press the [▲/▼] keys to select memory channel "06" in the memory mode.
2. Press the [FUNC] key, then press the [2] key.  
While [VFO] icon is flashing, use [▲/▼] keys to select VFO A or B to copy the data, then press [2] key to complete.

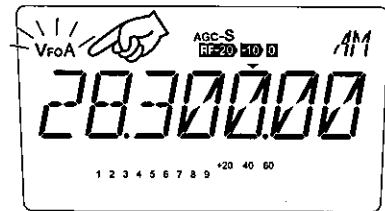

**NOTE:** After transfer, the original data still remains in the memory channel.

## 3-6 Channel Name (Alphanumeric) Registration Function

The memory channels stored in the memory mode can be displayed with an alphanumeric tag instead of the default frequency display. There are 67 characters available including A-Z, 0-9.

1. In the memory mode, select a channel to be programmed.
2. Press the [FUNC] key, then press the [ENT] key.
3. The display shows [A] flashing.
4. Turn the Main dial or press the [▲/▼] keys to select a character to be programmed.
5. By pressing the [ENT] key, the character stops flashing and is entered.  
An identical character to the one just entered flashes on the immediate right ready to be edited.

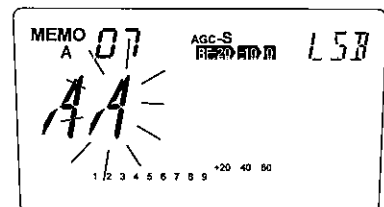
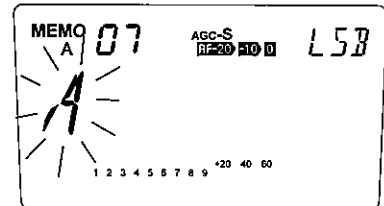



6. Enter the next character with the [ENT] key.  
(Repeat the same sequence)  
In order to store 6 letters for example, repeat the sequence until all 6 letters are entered by [ENT] key, and only 7th digit is flashing. To enter 7 letters, repeat until 1st digit flashes.
7. Pressing the [0] key during programming will delete all characters to be programmed.  
Pressing the [•] key to delete the last character.
8. Pressing any key other than the [ENT] key, [0] key, [•] key and [▲/▼] keys will complete the setting and the display will return to the original status.

**NOTE:** In the memory mode, a designated alphanumeric tag is displayed instead of the frequency. Press [FUNC] key to display the frequency temporary. Pressing [FUNC] key again or changing the memory channel will recall the alphanumeric display. In case [FUNC] key parameter is set to AUTO, it returns to the alphanumeric display automatically after 5 seconds.

By pressing any key during operation, the display will return to show the channel name. But by operating a key designated for some [FUNC] key, the unit will enter the designated setting mode.

While displaying the name-tag (alphanumeric display), when you perform frequency-related operation such as changing the frequency using the main dial, the display turns to numeric indication temporary for 5 seconds then goes back to the name-tag.

The following table lists available characters.

A	A	H	H	O	O	V	V	0	0	7	7
B	B	I	I	P	P	W	W	1	1	8	8
C	C	J	J	Q	Q	X	X	2	2	9	9
D	D	K	K	R	R	Y	Y	3	3		
E	E	L	L	S	S	Z	Z	4	4		
F	F	M	M	T	T			5	5		
G	G	N	N	U	U			6	6		

## 3-7 Quick Memory

Frequencies for amateur bands are stored for the keypad keys as the default setting in the DX-R8T/E as listed below. After pressing the [ENT] key, if a keypad key is pressed, the corresponding stored frequency will appear. This function is useful for storing the mid-frequency of the broadcast bands you often listen to or the frequencies of the broadcast stations that you most frequently receive.

To change the stored frequencies, first of all, display the frequencies you would like to store in VFO mode, and press the keypad key that you would like store while pressing the [FUNC] key. Carry out the above procedure quickly as if the [FUNC] key is held down for too long at this time, the unit will enter parameter setting mode.

Keypad	Default frequency (mode)
1	1.9000MHz(LSB)
2	3.6000MHz(LSB)
3	5.3305MHz(LSB)
4	7.1000MHz(LSB)
5	10.1000MHz(USB)
6	14.1000MHz(USB)
7	18.1000MHz(USB)
8	21.1000MHz(USB)
9	24.9000MHz(USB)
0	28.1000MHz(USB)



The memory name function can not be used.

# 4. Scanning

## 4-1 Basics

This function automatically changes the frequency and memory channel and searches for a signal. The DX-R8T/E has five scan modes: VFO scan, programmed scan, search scan, memory scan, and priority scan.

The setting parameters of the timer scan are not only be used for making the scan stop when a signal is detected but can also be used to receive digital signals such as Pactor or HFDL.

### Scan Modes

#### VFO scan

With this scan mode, scanning is carried out with the steps set in VFO mode. If all the bands that can possibly be received were to be scanned, the scanning time would be too long so with the DX-R8T/E, amateur bands are categorized as separate, and scanning is conducted by scanning inside and outside of the amateur bands which makes it easier to find the frequency band's wave.

Band (MHz)	Band range (MHz)		Step
	T version	E version	
1.8	1.8000 - 2.0000	1.8000 - 2.0000	Scanning is carried out with the frequency steps set in each mode.  SSB, CW : 0.1 kHz AM : 1.0 kHz FM : 2.5 kHz
3.5	3.5000 - 4.0000	3.4000 - 4.0000	
5.3	5.3305 - 5.4035	5.3305 - 5.4035	
7	7.0000 - 7.3000	6.9000 - 7.5000	
10	10.1000 - 10.1500	9.9000 - 10.5000	
14	14.0000 - 14.3500	13.9000 - 14.5000	
18	18.0680 - 18.1680	17.9000 - 18.5000	
21	21.0000 - 21.4500	20.9000 - 21.5000	
24	24.8900 - 24.9900	24.4000 - 25.1000	
28	28.0000 - 29.7000	28.0000 - 30.0000	

· For example, if scanning starts from 12.00000 MHz, scanning will be done in the range of 10.1500 MHz - 13.9999 MHz.

The inside of the amateur band and the frequencies between the amateur bands are repeatedly scanned.

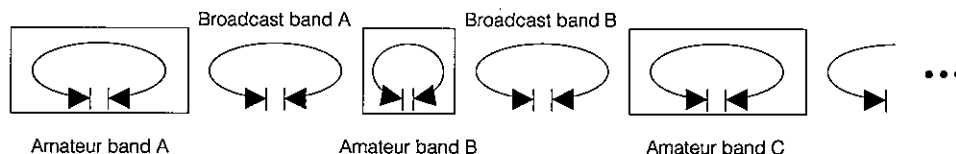

**Programmed scan**

This function scans an user-specified range of frequencies. Before using this function, you need to specify the upper and lower frequency limits for programmed-scanning. These frequencies are called "Programmed scan channels", and are available a pair in VFO A and VFO B separately. By referring to Page 37, set the upper and lower limit frequencies in the P1 and P2 channels of the memory-bank A for VFO-A, the bank B for VFO-B operations. The P1/P2 channels are not available in the Blank memory bank. The "P" on the display flashes during the Programmed Scan.



- NOTE:**
- The tuning step and modulation mode of the Program scan function are the same as those set for the VFO at moment of scanning.
  - The modulation mode stored in P1/P2 memories are always disregarded for programmed scan but P1/P2 channels can be used also as normal "memory channels" for memory operation.

**Search scan**

This search mode is convenient to high-speed scan pre-determined width of frequency regardless of the band of operation.

Suppose the selected range is 100 kHz in the Set mode, and current frequency is 7.102.83 MHz. By activating this function, it scans between 7.100.00 and 7.199.99 MHz shown as the range B below. Press [▲] key during the scan to move up to the next 100 kHz range that is C, or [▼] key to scan the range A. Setting 200 kHz in the Set mode scans both A and B, and pressing [▲] key will move to scan C and D range in this case. The "S" on the display flashes during the Search Scan. Press any key (other than the [▲/▼] keys) to stop scanning.

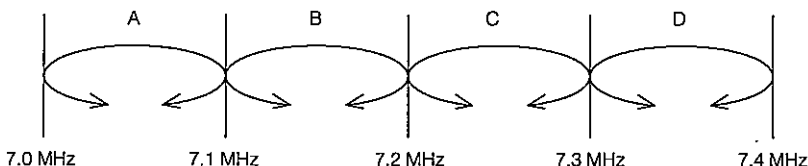

**Memory scan**

- This scan searches for signals in programmed memory channels by numerical order.
- Unprogrammed memory channels will be skipped.

It scans only programmed memory channels. Pressing the [▲] key will scan upwards and pressing the [▼] key will scan downwards through the channels.

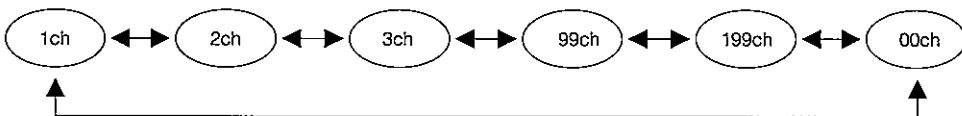

### Priority scan

- In this scan mode, for each 5 seconds the displayed frequency is received, the set channel (priority frequency) will be received for 0.5 seconds. At this time, if a signal is received and the squelch is open, the set channel is received for 2 seconds.

	Displayed frequency (5 seconds)	Priority frequency (0.5 seconds)
VFO A priority	VFO A	Memory
VFO B priority	VFO B	Memory
Memory priority A	Memory	VFO A
Memory priority B	Memory	VFO B

**NOTE: Priority scan interrupts the reception once every 5 seconds. Priority scan is recommended to receive communications, not broadcasting signals.**

## Scanning Conditions

An explanation of the details of how to operate each scan mode can be found under the next item.

The conditions under which the scan will start are as follows:

### Scan mode

The pause conditions and resumption conditions for VFO scan, programmed scan, and memory scan can be set in the parameter setting mode. (See page 28)

### Start of scan

1. To start the VFO scan or memory scan, press the [FUNC] key, then press the [4] key.
2. To start the programmed scan, press the [FUNC] key, then press the [5] key.
3. To start the search scan, press the [FUNC] key, then press the [6] key.

## 4-2 VFO Scan

1. Enter to either the VFO A or B in the VFO mode.
2. Press the [FUNC] key, then press the [4] key to start scanning. During this scan mode, the decimal points flash as shown.
3. Use the [▲/▼] keys to change the scan direction. Press any key (other than the [▲/▼] keys) to exit.

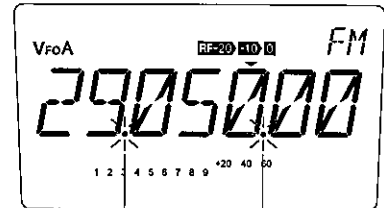

These flash during scanning

- NOTE:**
- In the SSB or CW mode, the scan is not likely to pause at a frequency where the received sound is clear. By setting the resumption time long enough, you can fine-tune the frequency using the RIT control knob while the scan pauses.
  - The scan proceeds to the upper limit of the band and returns to the lower limit of the band, or vice versa.
  - Set the frequency step according to the band and modulation mode used there. For example, select a 10 kHz step in 29 MHz FM band for faster scanning.

## 4-3 Programmed Scan

1. Enter to the VFO A or B in the VFO mode.  
Be sure that the P1/P2 channels are correctly programmed in the memory channels prior to use this scan mode.
2. Press the [FUNC] key, then press the [5] key to start scanning. During this scan mode, the decimal point and "P" flash as shown.
3. Use the [▲/▼] keys to change the scan direction. Press any key (other than the [▲/▼] keys) to exit.

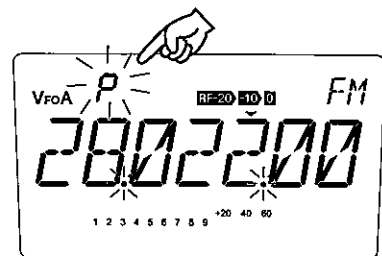

- NOTE:** Regardless of the current VFO frequency, the scanning range will be set in the VFO automatically when the scan starts.

## 4-4 Search Scan

By setting the Search scan in the Set mode Menu 04 and 100 kHz in the Menu 05:

1. Enter to either the VFO A or B in the VFO mode.
2. Set any frequency to scan in 100 kHz range and the modulation mode you desire.
3. Press the [FUNC] key, then press the [6] key to start scanning. During this scan mode, the decimal point and "S" flash as shown.
4. Use the [▲/▼] keys to change the scan direction. Press any key (other than the [▲/▼] keys) to exit.

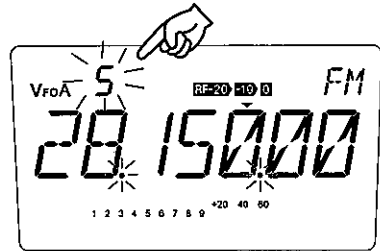

## 4-5 Memory Scan

To scan the memory channels stored in the selected memory bank:

1. Enter to either one of the memory banks. The memory indication appears like an example on upper left corner of the display.
2. Press the [FUNC] key, then press the [8] key to start scanning. During this scan mode, the decimal points flash as shown.
3. Use the [▲/▼] keys to change the scan direction. Press any key (other than the [▲/▼] keys) to exit.

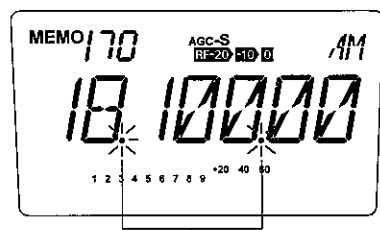

These flash during scanning

## 4-6 Skip-channel Setting

Memory channels that are set as skip-channels will be excluded from scanning during Memory Scan. This designation can be set even after the memory is programmed.

1. Press the [FUNC] key in the Memory mode, and then press the [V/M] key while the FUNC icon is displayed. Skip setting of a memory channel selected is now in place.

A decimal point will appear as shown when skip channels are set.

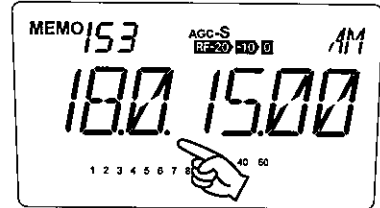

**NOTE:** The same decimal point will appear when the alphanumeric tag is set.

2. To cancel the skip-channel setting, repeat the step 1.

**IMPORTANT:** P1 and P2 are always skipped.



## 4-7 Priority Scan

You can monitor 2 frequencies every 5/0.5 seconds alternatively. Any combination of VFO and/or memory channel frequency can be coupled for priority monitoring. Stay tuned to the main frequency you wish to monitor for 5 seconds, and select the priority frequency (or channel) to monitor 0.5 seconds (and stay there for 2 seconds if a signal is picked up).

Example: Receiving the VFO A and monitoring a memory channel as a priority channel.

1. Enter to the memory mode and select a channel to monitor as a priority.

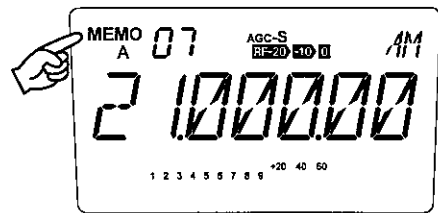

2. Press the [V/M] key to enter to the VFO mode and tune to a frequency you wish to monitor for 5 seconds.

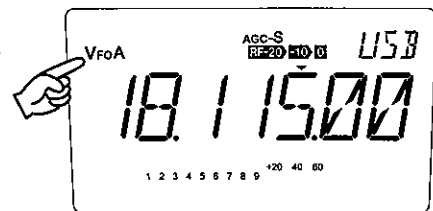

3. Press the [FUNC] key, then press the [8] key to start the priority monitoring. Press any key (other than the [▲/▼] keys) to exit.

# 5. Other Functions

## 5-1 Interference Reducers

### Introduction

As explained in previous chapters, this receiver has built-in functions to reduce interferences. This section explains how to use these functions to reduce interference in detail, although you may be already familiar with these features.

### IF SHIFT

The IF SHIFT function is used to shift the IF pass band without changing the receive frequency. If there is an interference signal near the received signal, rotate the  $\Delta$ IF control knob to get the interference signal out of the receive band.

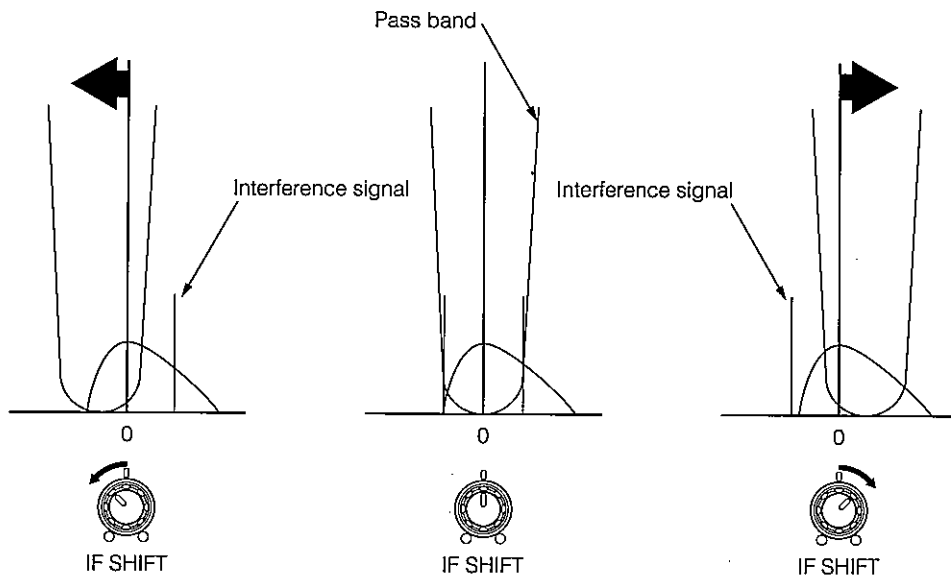

- NOTE:**
- This function can shift the IF pass band within a range of only  $\pm 1.5$  kHz.
  - This function will be disabled in the AM and FM modes.
  - This function can also be used to adjust the audio quality to suit your preferences.

## Narrow Filter

The narrow filter can be used in AM, SSB and CW mode. This allows you to effectively reduce interference.

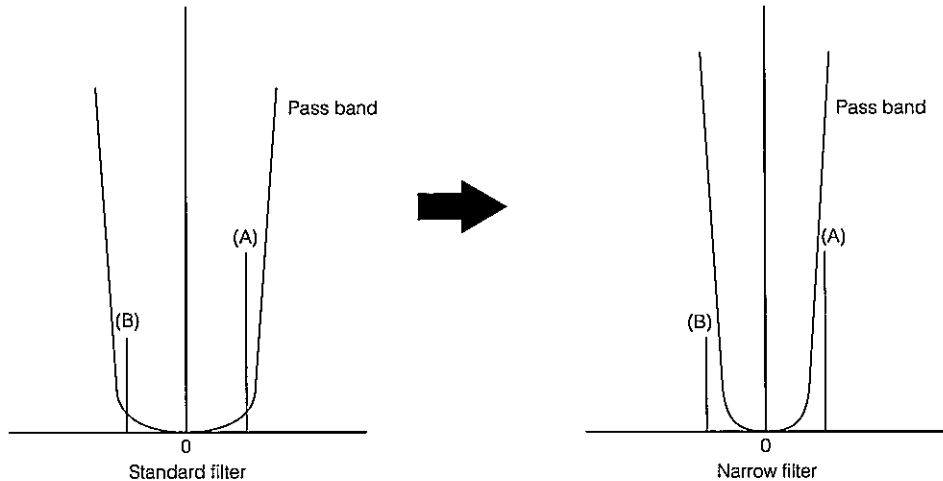

- If there are interference signals (A) and (B) when the standard filter is used, using the narrow filter will reduce the interference.

**NOTE: Using the narrow filter will change the audio slightly.**

· Filter band width (KHz)

Mode	Wide filter	Narrow filter
CW	1.0	0.5
SSB	2.4	1.0
AM	9	2.4
FM	9	Narrow filter cannot be used

1. Press the [FUNC] key then press the [RF] key.
  - “Nar” appears on the LCD display.
2. Repeat the same sequence to switch between the Standard/Narrow filters.
  - To clarify the received signal, use the ΔIF function together.

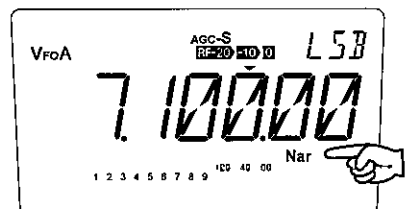

**NOTE: Use of narrow filter may result in poorer performance to operate some data-modes. Be mindful to switch the filter according to your operation mode.**

## CW BFO REVERSE

The CW mode has CWU (upper sideband) and CWL (lower sideband) options. Selecting the CWU or CWL can help reduce interference.

When your receive frequency is zeroed-in with the other station's transmit frequency, this function would not affect the receive tone.

1. Press the [MODE] key to select the CWU or CWL mode.  
Or, press and hold the [MODE] key to flash MODE. Select the mode using the [▲/▼] keys. Any key operation stops flashing the mode display.

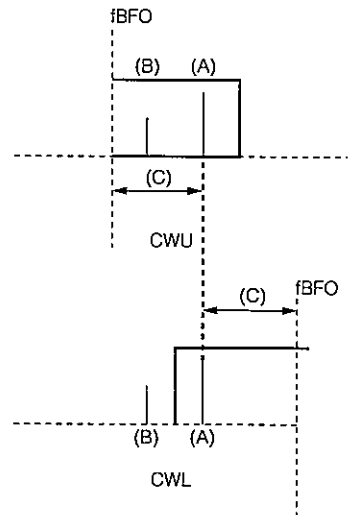

- (A) Target signal
- (B) Interference signal
- (C) Reception pitch

## NB (Noise Blanker)

The noise blanker suppresses pulse noise generated by car ignition etc to clarify the receiving signal.

1. Press the [FUNC] key then press the [9] key. The "NB" icon will be displayed.

**NOTE:** Do NOT leave this function activated always. As a side-effect, adjacent strong signals may cause interferences to your receiving frequency.

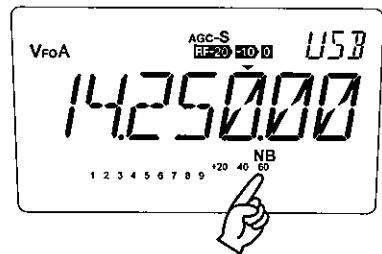

## 5-2 Other Useful Functions

### RIT Function

Once tuned in the signal, instead of using the main dial, RIT may be used to fine-tune during the reception. RIT vary the frequencies within the range of  $\pm 1.2$  kHz.

1. Press the [RIT] key. The displayed icon will change in the following manner.

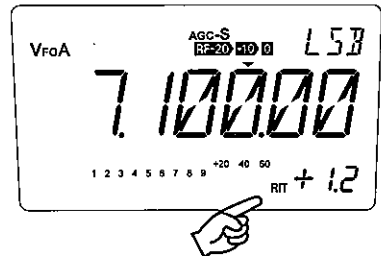
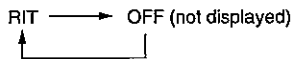

- IMPORTANT:**
- Never operate the main dial while you are using RIT functions. It will change the original operating frequency causing interferences to adjacent stations or off-frequency from your communicating station. Be extra-cautious always to exit from RIT operation before start using the main dial.
  - $\pm\Delta f$  feature explained in the following section is another very useful way to exit from RIT and start operating with the main dial.

### $\pm\Delta f$ (Plus-Minus Delta F) Function

This feature adds current RIT values to the original operating frequency and exits from the RIT function.

#### Procedure

1. While operating RIT, press [FUNC] key.
2. Press the [RIT] key to complete the procedure. RIT icon disappears.

**NOTE:** Observe the RIT value shown with a finger. It indicates +1.1, but actually it could be any number between 1.10 to 1.19 kHz, because of the frequency display resolution. Therefore like in this example, instead of being added by 1.00 kHz exactly, 1.15 kHz may be added to the original frequency respecting the actual RIT values.

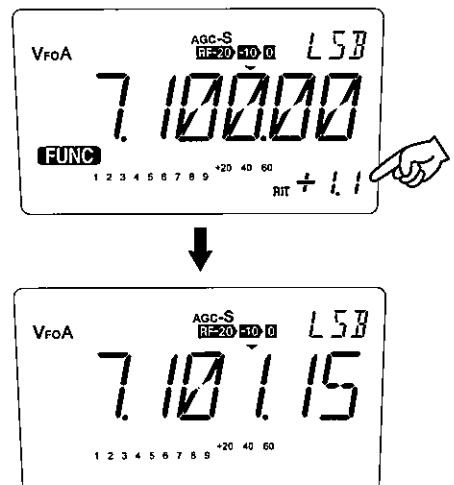

## VFO A=B Function

This function copies the VFO setting A to B or vice versa.

**NOTE:** This is useful when you wish to move to another similar operating condition by just slightly changing some settings, leaving the original status, or switch between these 2 conditions.

### Procedure

1. Set the VFO as you desire.

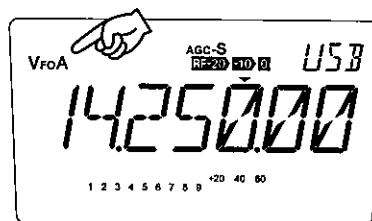

2. Hold the [V/M] key for more than one second. A beep sounds (but nothing changes on the display). Press the [FUNC] then press the [1] key to copy the VFO status to another VFO and remain there.

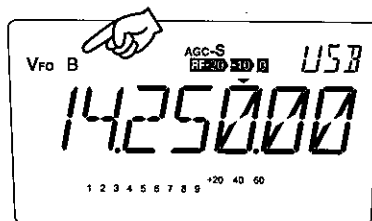

## MULTI FUNCTION Feature

Any key operation can be assigned to the [MF] key as a short-cut.

\* All key functions and Set mode parameters can be assigned to this feature.

Example: Assign the scan speed setting in the Set mode to the [MF] key.

1. Press the [FUNC] key, then press the [MF] key. The ★ icon flashes.

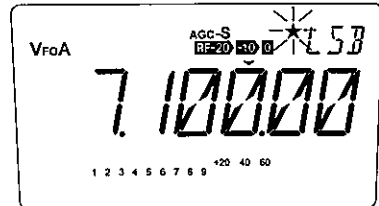

2. Press the [FUNC] key for more than 1 second.  
"SET" will appear indicating the receiver is in the Parameter Setting mode.

3. Select the timer scan setting menu by pressing the [▲/▼] keys.  
\* See Menu 03 on page 52 to select the timer scan setting.

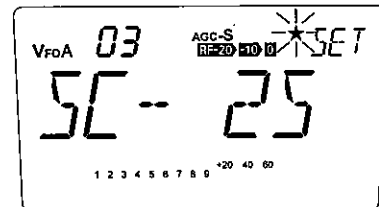

4. Press any key other than [▲/▼] key.

5. Press the [MF] key. The ★ stops flashing.

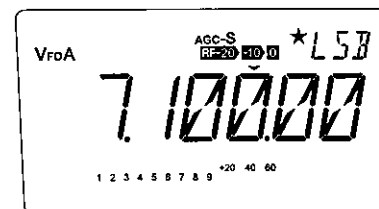

6. Press the [MF] key, the display show the timer scan setting menu.

\* You can assign different functions at any time you may so wish by just repeating above procedure.

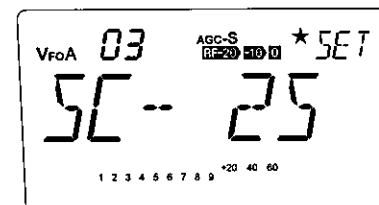

## DIAL LOCK Function

This function locks the main tuning dial to prevent accidental frequency changes.

**NOTE:** While this function is activated, tuning is still possible with the [▲/▼] keys and RIT control knob.

### Procedure

1. Press the [O-] key.  
 O- will appear.  
 • To cancel this function, press the [O-] key again.

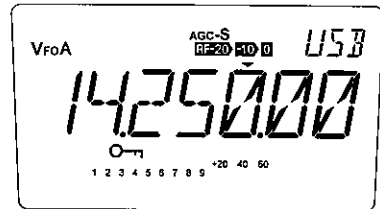

## KEY LOCK Function

Key lock function blocks operations of the main dial and most of other key operations. In the Key-lock status, only the following operations are permitted other than the Power ON/OFF and the [FUNC] key operation.

[Functions permitted during the Key-lock]

- AF level • Squelch level • IF shift • RIT (if activated in advance)

1. Press the [FUNC] key, then press the [O-] key.

2. O- will flash.  
 • To cancel this function, press the [FUNC] key, then press the [O-] key again.

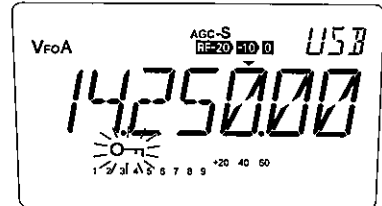

## Dimmer

The LCD illumination dimmer is available to adjust the luminosity of the display as you prefer.

1. Press the [FUNC] key, then press the [.] key to make "DIMR-32" appear in the display.

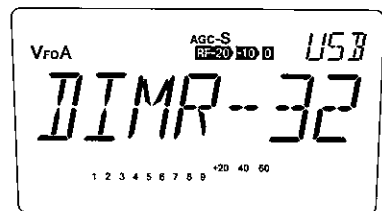

2. Set the brightness to your preference by rotating the main tuning dial. "DIMR-00" turns the light off. Press any key to return to the frequency display.

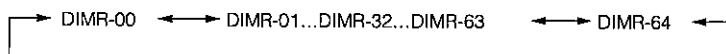



## Beep Sound

The beep that sounds during operation can be turned off.

1. If the [FUNC] key is pressed, then the [0] key is pressed, the beep sound can be switched from being on to off and vice versa. When set to "OFF" the beep will not sound.

## Sleep

This feature is useful to turn off the DX-R8 automatically. In Sleep mode, the power turns off regardless of the operating condition when preset time is elapsed.

1. Select the Sleep time in menu 08 of the parameter setting mode. (see P.55)

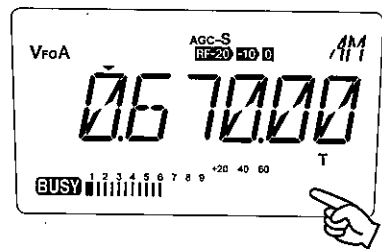

2. Press [FUNC] key and the [7] key to activate. A "T" icon appears on the display.

## CABLE CLONE

This feature will copy the programmed data and parameters in the master unit to slave units. It copies the parameters and memory program settings.

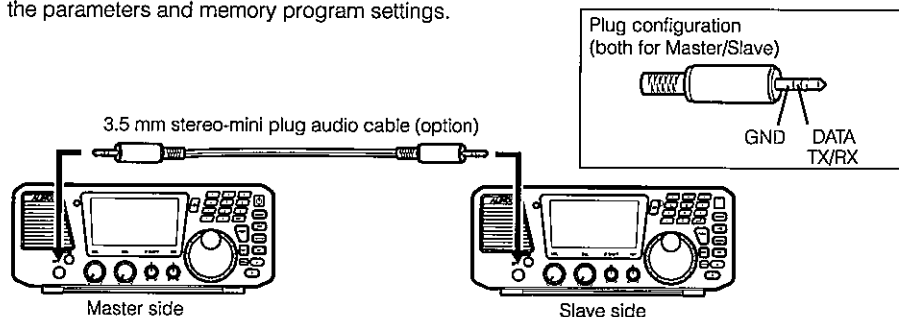

### Connection

Make a cable using 3.5 mm stereo-mini plugs as shown above or purchase one. Make a master unit by setting and programming it as desired. Turn off both units. Connect the cable between the Speaker jacks on both master and slave. Turn both radios on after the connection is made.

**IMPORTANT: Be sure to connect cables while the units are turned OFF.**

#### [Slave side]

1. Go to receive mode (VFO or Memory) and stand-by.
2. When the cloning starts, LD\*\*\* shows up on the display.
3. When the cloning is successfully completed, the display will show [PASS].
4. Turn off the power. Disconnect the cable and repeat the sequence to clone the next slave unit.

#### [Master side]

1. Turn the power on while pressing the [MODE] key. CLONE will be displayed and the radio enters the clone mode.
2. Press [MF] key. SD\*\*\* will be displayed and it starts sending the data into the slave unit.
3. [PASS] will appear on the display when the data is successfully transmitted.
4. The master unit may stay turned on for the next clone, or turn off the unit to exit from the clone mode.

If the data is not successfully transmitted, [ERROR] will appear on the display. Turn off both units, make sure the cable connection is correct and repeat the entire operation from the beginning. If you quit the operation in condition that the clone is incompleted, please ALL-reset the slave unit by referring to P.58.

# 6. Parameter Setting Mode (Set mode)

**IMPORTANT:** Please read the following pages thoroughly prior to the change of any parameters. THE PARAMETERS CANNOT BE SET WITHOUT ENTERING THE SET MODE.

By entering the Parameter Setting mode, some of the radio's operating parameters can be changed to suit your preferences. The following is the Selectable Parameters' Menu.

## Table of Setting Mode Parameters

### A List

Menu	Default display	Function	Default setting
00	SSB-0.1	Frequency step of the [▲/▼] keys setting	0.1KHz
	AM-1.0		1.0KHz
	FM-2.5		2.5KHz
01	PROT-OFF	Memory overwrite protection	OFF
02	ACCS-ON	Memory frequency access protection	ON
03	SC-2S	Timer scan setting	2S
04	SSC-50	Search range setting for search scan	50KHz
05	SKIP	Memory scan skip setting	SKIP
06	U/L-ON	Automatic USB/LSB selection	ON
07	AGC-ON	Automatic AGC-S/AGC-F selection	ON
08	SLP-60	Sleep time setting	60 minutes
09	APC-OFF	Automatic power off	OFF
10	KRPT-ON	Repeat setting for [▲/▼] keys	ON
11	FUNC-MN	*FUNC* display resume setting	Manual
12	LED-OFF	RX lamp setting	OFF
13	CP-800	CW pitch frequency setting	800Hz
14	TC-MUTE	AF mute setting	MUTE

## To Use the Parameter Setting Mode

1. Press [FUNC] key for more than 1 second. Alphanumeric characters will appear indicating the transceiver is in the Parameter Setting mode. Please observe the menu number to understand which parameter you are currently dealing with.
2. Select a menu by pressing the [▲/▼] keys.
3. Rotate the main dial to change the desired setting. In case the available parameter is 2 items, such as ON/OFF, rotate the dial clockwise or counterclockwise to select either one.
4. Press [▲/▼] keys again to set the selected parameter and move to the next programming.
5. Press any key other than [▲/▼] keys to set the selected parameter and exit from the Parameter setting mode. A beep sounds.

## Menu 00. Setting Frequency Step with the [▲/▼] Keys

### SSB and CW Mode

1. While the unit is in SSB or CW mode, enter into the Set mode and select menu 00.

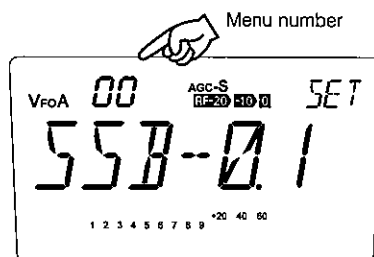

2. The current frequency step will be displayed.

3. You can change the frequency step as below by rotating the main dial.

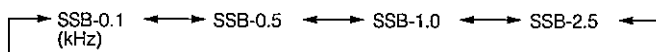

### AM Mode

1. While the unit is in AM mode, enter into the Set mode and select menu 00.

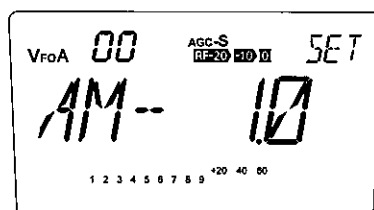

2. The current frequency step will be displayed.

3. You can change the frequency step as below by rotating the main dial.

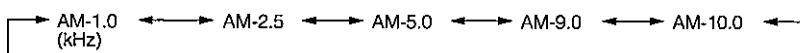

### FM Mode

1. While the unit is in FM mode, enter into the Set mode and select menu 00.

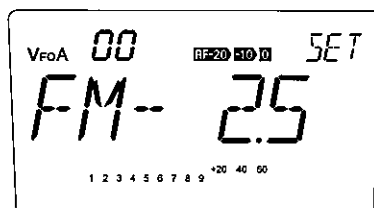

2. The current frequency step will be displayed.

3. You can change the frequency step as below by rotating the main dial.

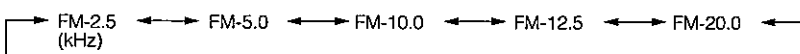

## IQ Mode

1. While the unit is in IQ mode, enter into the Set mode and select menu 00.
2. The current frequency step will be displayed.
3. You can change the frequency step as below by rotating the main dial.

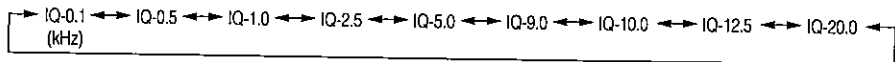
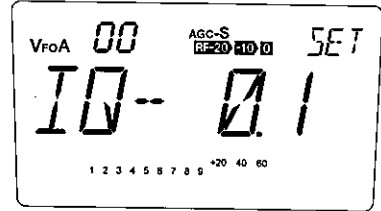

## Menu 01. Memory Overwrite Protection

This function protects all memory channels from accidental overwriting.

1. The [PROT-OF] appears on the display.  
(Default)
2. Turn the main dial clockwise, the display changes into the [PROT-ON] and the Memory Overwrite Protection is activated.

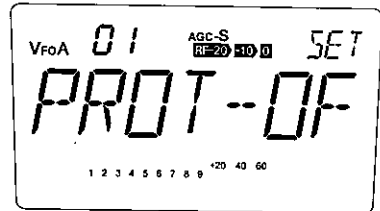

PROT-OF ← → PROT-ON

**NOTE:** The feature determines only allows or prohibits “memory overwrite”.  
Memory data erase is still possible regardless of this parameter.

## Menu 02. Memory Frequency Access Protection

Memory frequencies can be temporary changed by using main dial etc. during the operation.

However, by selecting ACCS-OF here, the memory frequency can't be changed except by using RIT. This is not a key-lock therefore you can still temporary alter other functions in memory like output, mode, RF gain etc. even OF is selected.

1. The [ACCS-ON] appears on the display.  
(Default)
2. Turn the main dial counterclockwise, the display changes into the [ACCS-OF] and the Memory Frequency Access Protection is changed.

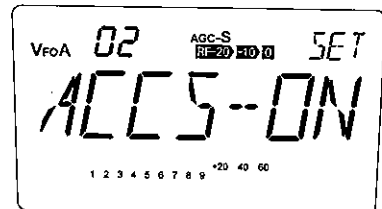

← counterclockwise ACCS-OF ↔ clockwise ACCS-ON →

## Menu 03. Timer Scan Setting

Each Scan mode has specific condition for stopping and resuming scanning. Select one of the conditions below for your scan operation.

1. The current timer scan setting will be displayed.

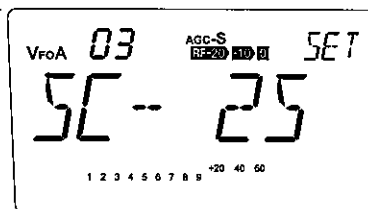

2. You can change the scan condition as below by rotating the main dial.

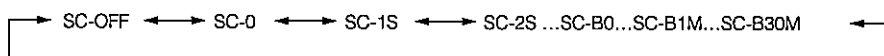

### Setting values and operations of timer scan

SC-OFF	The scan stops scanning when a signal is received, and the scan is canceled.
0	The scan stops scanning when a signal is received, and continues to receive the signal until it is lost. Scanning resumes when the signal is lost under the same conditions. This setting is useful when the squelch is being used when searching for a strong communication signal.
1S 2S 3S 5S 7S 10S	For settings "1S" to "10S", when a signal is received, scanning stops, and remains so for the set amount of time regardless of whether there is a signal or not, and then resume scanning under the same conditions. The units used are seconds. "1S" means 1 second, and "10S" means 10 seconds. For settings "0" to "10S", if the squelch is closed, the scan will skip areas that have no signal. If the squelch is opened, the scan moves to the next frequency step when the specified time has elapsed. These settings are useful for searching for signals that give out a constant wave such as broadcasts.
B0	The scan will not stop scanning even when a signal is received. This setting is useful when you want to use the search scan in memory mode.
B1S B2S ⋮ B10M B20M B30M	For settings "B1S" to "B30M", the scan continues for the specified time, regardless of whether there is a signal or not. The scan functions in the same manner regardless of whether the squelch is open or closed. Regardless of whether there is a signal or not, the scan continues scanning until the specified time and then moves to the next frequency step. The units used are seconds. "1S" means 1 second, "1M" means 1 minute, and "30M" means 30 minutes. When, for example, you want to receive, for example, HF DL, NAVTEX, or FAX data from multiple channels, if you input those channels into the memory and set the time to 3 or 5 minutes, the DX-R8T/E will automatically scan the input channels and receive data per the set time period.

## Menu 04. Search Range Setting for Search Scan

This is to set the scanning range applied to Search scanning. 50, 100 and 200 kHz are available as parameters.

1. Default range is [SSC-50].

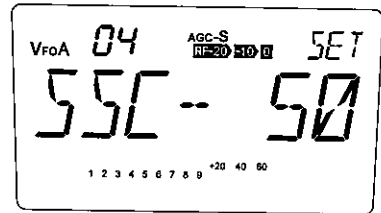

2. Rotate the main dial to select the scanning range.

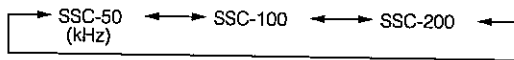

## Menu 05. Memory Scan Skip Setting

This is to select either to include or exclude the memory-skip channels during the memory scanning.

1. Default is [SKIP].

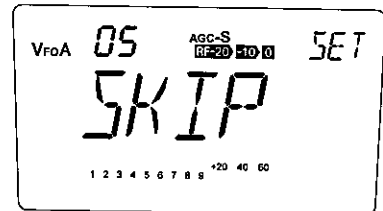

2. Rotate the main dial counterclockwise to select [NO SKIP].

NO SKIP ↔ SKIP

[SKIP].....Excludes skip channels during the memory scanning.

[NO SKIP] .....Includes skip channels during the memory scanning.

## Menu 06. Automatic USB/LSB Selection

This function automatically selects the USB or LSB mode depending on which amateur radio band has been selected in SSB mode. If "OFF" is selected, the last-used SSB mode is recalled regardless of the band.

1. The [U/L-ON] appears on the display.  
(Default)

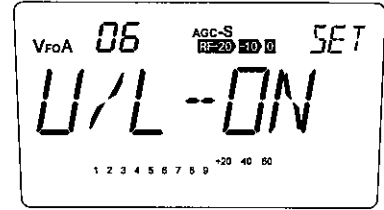

2. Turn the main dial counterclockwise, the display changes into the [U/L-OFF] to select USB/LSB manually.

U/L-OFF ←→ U/L-ON

**NOTE:** Even ON is set, manual selection of USB/LSB is still possible during the operation but returns to automatic when the power is turned off.

## Menu 07. Automatic AGC-S/AGC-F Selection

This function allows automatically select the AGC-S or AGC-F in accordance with the modulation mode.

1. Default range is [AGC-ON].
2. Rotate the main dial counterclockwise to select [AGC-OFF] to set it manually.

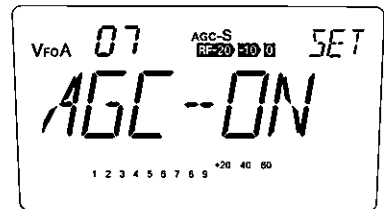

AGC-OFF ←→ AGC-ON

In AGC-ON state, AGC will be automatically selected to:

SSB, AM ..... AGC-S

CW ..... AGC-F

**NOTE:** A manual selection of AGC is still possible even the parameter is set to ON position by operating [FUNC] and [M/KHz] key. It resets to automatic when the power is turned off.



## Menu 08. Sleep Time Setting

The sleep feature turns off the power after the desired time is elapsed regardless of operation status.

1. The default setting is "SLP-60" (60 minutes).

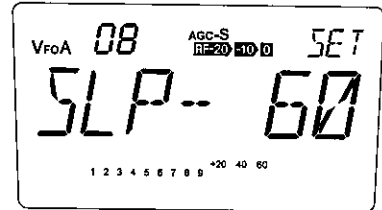

2. Use the main tuning dial to set the sleep time setting between 10 minutes and 180 minutes in increments of 10 minutes.

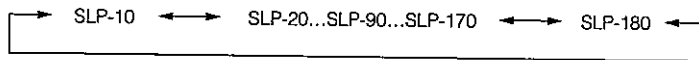

## Menu 09. Automatic Power Off (APO)

The APO feature turns off the power after the desired time is elapsed without any key operation. If the receiver is operated by using keys, the timer is reset and resumes count-down.

1. The default setting is "APO-OFF".

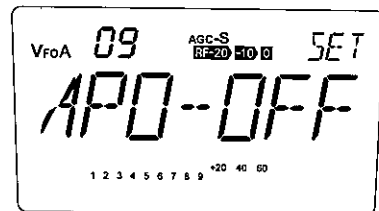

2. Use the main tuning dial to set the APO to on or off, and to set the time after which the power supply will be turned off.

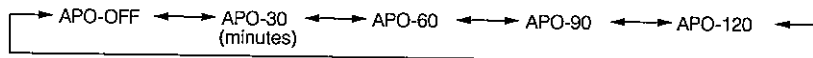

**NOTE: Even if the below are operated, the APO time won't be reset.**

· VOL · SQL · IF SHIFT · RIT · Main tuning dial

## Menu 10. [▲/▼] Keys Repeat Setting

Function for pressing [▲/▼] keys can be set to a key-repeat to increase/decrease values continuously (and faster) while holding down the key.

1. The default is [KRPT-ON] that is key-repeat function. Pressing and holding [▲/▼] key will continuously change values like frequency etc.
2. Rotate the main dial clockwise to select "ON" or "OFF".

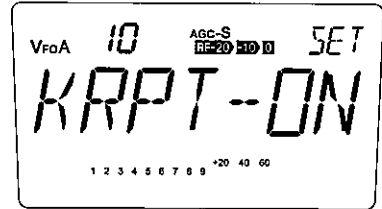

KRPT-OFF ←→ KRPT-ON

## Menu 11. FUNC Key Resume Timing Setting

The FUNC key resume timing can be set to manual or auto as below:

FUNC-MN (manual resume) ..... FUNC key operation remains until the next key is pressed.

FUNC-AT (Auto) ..... FUNC key operation will be canceled automatically and FUNC indication on the display turns off when no operation is performed within 5 seconds.

1. The default is [FUNC-MN].
2. Rotate the main dial clockwise to select [FUNC-AT]. Automatic FUNC operation is activated.

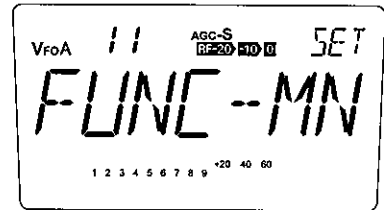

FUNC-MN ←→ FUNC-AT

**NOTE: It is recommended to use "MN" setting until you get familiar with the operations of DX-R8.**

## Menu 12. RX Lamp Setting

An LED in the top left of the display can be lit when receiving a signal or squelch is unmute.

1. The default setting is "LED-OFF".
2. Use the main tuning dial to select the color of the light (green or red).

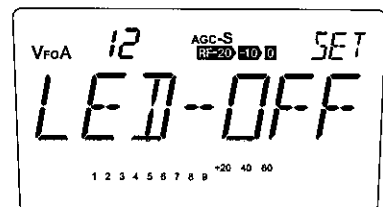

→ LED-OFF ←→ LED-GRN (green) ←→ LED-RED (red) ←

## Menu 13. CW Pitch Frequency Setting

The sidetone will change according to the CW offset you select.

1. The [CP-800] appears on the display.  
(Default)
2. By rotating the main dial, the display changes as shown and the sidetone is changed.

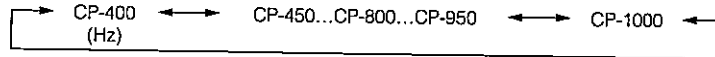
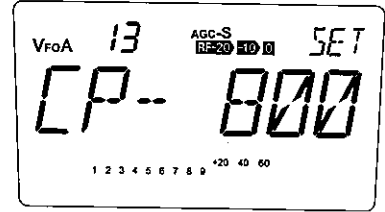

## Menu 14. AF Mute Setting

This is an advanced setting and not required for a normal use. By inputting a command from another device such as a transmitter to this terminal on the rear panel, you can mute the AF output audio or switching the VFO from A to B or vice versa.

1. The default is TC-MUTE and the audio mutes by grounding the terminal.
2. Select TC-VFO by turning the dial switches VFO A and B when the terminal is grounded.

TC-MUTE ↔ TC-VFO

**NOTE:** This is not a transceive-function to use a separate transmitter or transceiver as the receiver circuit of DX-R8 is still alive and receiving signals even while the audio is mute. Be cautious not to overload the front-end circuit of DX-R8 by transmitting HF signals from an antenna set up close to DX-R8's receiving antenna.

## Menu 15. IQ Shift Setting

Some SDR software requires an input IQ signal slightly different from the actual receiving frequency. In order to tune to the frequency without considering and calculating such "shift" while operating with SDR software (typically DRM decoder software for example), IQ shift setting is available.

1. The selectable shift frequency range is from -24KHz to +24KHz. The default value is without shift function and 0 is displayed.
2. Use the main dial to select the shift width you desire in 10Hz step.
3. Exit the setting mode to activate the function. "-IQ" is displayed when -direction shift is being set, "+IQ" for + shift.
4. To deactivate this function, repeat above to select 0. The mode will be simply displayed as "IQ".

**NOTE:** To use SDR software that require a signal conversion of several KHz using a converter for PC-input, such conversion could be replaced by using the IQ mode and IQ shift function.

For example, to use a popular DRM decoding software "DREAM", simply connect to DX-R8 with a Line-in port of your PC sound-card terminal using a simple 3.5 mm stereo mini-plug cable without any converter and set the IQ shift to about + 5 to +15KHz. A fine-tuning may be required for the first time depending on your receiving condition by monitoring the indicators of the software using the main dial of the receiver. Adjust the IQ shift then, so that fine-tuning won't be necessary from the next time. If the software configuration has been set correctly and a good S/N ratio is obtained from the receiving signal, you should be able to enjoy an FM-broadcasting alike, hi-fi quality program in shortwave bands.

# 7. Maintenance and Reference

## 7-1 Reset

There are 3 types of reset modes in DX-R8.

1. System reset: Resets functions and Set mode parameters. Memory data remain unchanged.  
THIS IS THE MOST RECOMMENDED RESET OPERATION.
2. Memory reset: Resets memory channel data only.
3. ALL reset: Resets all customized parameters and memories to return to the factory-default condition.  
CAUTION! MEMORY DATA CAN'T BE RECALLED ONCE DELETED.

### Procedure

1. System reset: Turn off, then turn on with [V/M] key pressed.
2. Memory reset: Turn off, then turn on with [M/KHz] and [RF] keys pressed together.
3. ALL reset: Turn off then turn on with [FUNC] key pressed.

**NOTE:**

- None of reset can restore previous data once the reset is completed. It is recommended to write important setting parameters and/or memory frequency information on blank pages available at the end of this manual for your future references.
- It is recommended to use reset features whenever you get lost with the explanation of this manual until you get familiar with the functions of DX-R8.

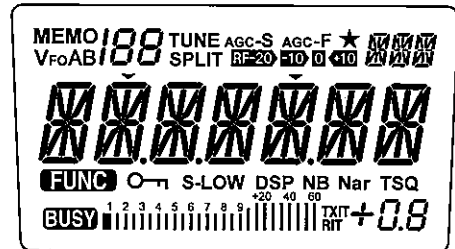

ALL LCD Segments

## 7-2 Cleaning

Regular cleaning is recommended to use this product in appropriate conditions.

- \* Be sure turn off and remove from the power source to clean the product.
- \* Use of cleaning devices made especially for delicate equipment such as personal computer or digital video/camera, like special wet-tissues, anti-static brushes, dry rubber-blower etc. is suitable to clean the surface of this product and accessories also.
- \* Never use thinner, benzene, alcohol or any liquid solvent otherwise damages the product and voids warranty.
- \* Never use unauthorized contact-cleaners, oil, spray-blower and other materials may be used to clean home appliances. They may not be suitable for delicate products like transceivers.  
Troubles caused by use of such materials will void the warranty of this product.

## 7-3 Troubleshooting

If a problem should occur, first try the troubleshooting procedure given below. If the problem persists, contact your nearest ALINCO dealer for technical assistances.

Symptom	Possible Cause	Remedy
Power does not come on.	<ol style="list-style-type: none"> <li>1. DC power cable is incorrectly connected.</li> <li>2. Fuse is blown.</li> <li>3. Plug polarity is wrong.</li> <li>4. Power switch of DC regulated power supply is off.</li> <li>5. Voltage from the power supply is insufficient.</li> </ol>	<ol style="list-style-type: none"> <li>1. Correctly connect cable.</li> <li>2. Replace fuse.</li> <li>3. Correct polarity and replace fuse.</li> <li>4. Turn power switch on.</li> <li>5. Supply a regulated 13.8 V DC <math>\pm</math> 15 %</li> </ol>
LCD display related troubles.	<ol style="list-style-type: none"> <li>1. Power supply voltage is low.</li> <li>2. No illumination.</li> </ol>	<ol style="list-style-type: none"> <li>1. • Check that DC regulated power supply is used. • Adjust the operating voltage within a range of 13.8 V DC <math>\pm</math> 15 % (11.7 to 15.8 V DC).</li> <li>2. Check the Set mode's dimmer setting (page 46)</li> </ol>
No sound from speaker.	<ol style="list-style-type: none"> <li>1. AF control knob is turned fully counterclockwise.</li> <li>2. External speaker cable is short-circuited or damaged.</li> <li>3. Headphones or earphone is plugged into the speaker jack.</li> <li>4. Squelch level is set too high.</li> </ol>	<ol style="list-style-type: none"> <li>1. Rotate AF control knob to adjust volume. (page 19)</li> <li>2. Check cable.</li> <li>3. Unplug headphones or earphone. (page 12)</li> <li>4. Turn SQL control knob counterclockwise to unmute squelch. (page 19)</li> </ol>
Only strong signals are received.	<ol style="list-style-type: none"> <li>1. Squelch is muted.</li> <li>2. ATT is on.</li> <li>3. Defective antenna or short-circuited or damaged coaxial cable.</li> <li>4. Antenna is not suitable for receiving band.</li> </ol>	<ol style="list-style-type: none"> <li>1. Turn SQL control knob counterclockwise. (page 19)</li> <li>2. Press [RF] key to turn ATT off. (page 22)</li> <li>3. Check antenna, cable, and connector. (page 11)</li> <li>4. Connect correct antenna.</li> </ol>
Received signal is not demodulated.	<ol style="list-style-type: none"> <li>1. Wrong mode is set. (If SSB, also check LSB and USB)</li> <li>2. Wrong passband is set.</li> </ol>	<ol style="list-style-type: none"> <li>1. Press the mode key (page 19) to select a correct mode.</li> <li>2. • Turn <math>\Delta</math> IF control knob to a position where proper audio can be heard. (page 40) • Select proper filter. (page 41)</li> </ol>
No frequency change when rotating the main tuning dial.	<ol style="list-style-type: none"> <li>1. Dial is locked.</li> </ol>	<ol style="list-style-type: none"> <li>1. Press [  ] key to free dial. (page 46)</li> </ol>
Scan does not start.	<ol style="list-style-type: none"> <li>1. Scan setting is incorrect in the Set mode or squelch is unmute.</li> </ol>	<ol style="list-style-type: none"> <li>1. Correct the scan type (page 33) or mute the squelch.</li> </ol>
Cannot access Memory mode.	<ol style="list-style-type: none"> <li>1. Memory channel is unprogrammed.</li> </ol>	<ol style="list-style-type: none"> <li>1. Program memory channel. (page 27)</li> </ol>
Memory scan will not start.	<ol style="list-style-type: none"> <li>1. Memory channel is unprogrammed.</li> </ol>	<ol style="list-style-type: none"> <li>1. Program memory channel. (page 27)</li> </ol>
Memory channel cannot be reprogrammed.	<ol style="list-style-type: none"> <li>1. Memory frequency overwrite protection is activated.</li> </ol>	<ol style="list-style-type: none"> <li>1. Turn off memory overwrite protection. (page 51)</li> </ol>
Memory frequency cannot be changed.	<ol style="list-style-type: none"> <li>1. Memory channel is protected.</li> </ol>	<ol style="list-style-type: none"> <li>1. Turn off memory access protection. (page 51)</li> </ol>

# Appendix

## Options

- EDS-17 Front control separator kit (5 m cable)
- EDC-37 DC power cable (spare)
- EDC-36 cigar cable with noise filter
- EF0010 3 A fuse for use with EDC-37 (spare)
- ERW-7 PC connection cable

## About Mounting Bracket and Carrying Handle

**CAUTION:** Use only specified screws otherwise may cause damages to the components inside and voids warranty.

Screw holes for mounting bracket

Use a third-party mounting bracket for mobile operation.

Ask your dealer about availabilities of the bracket and handle.

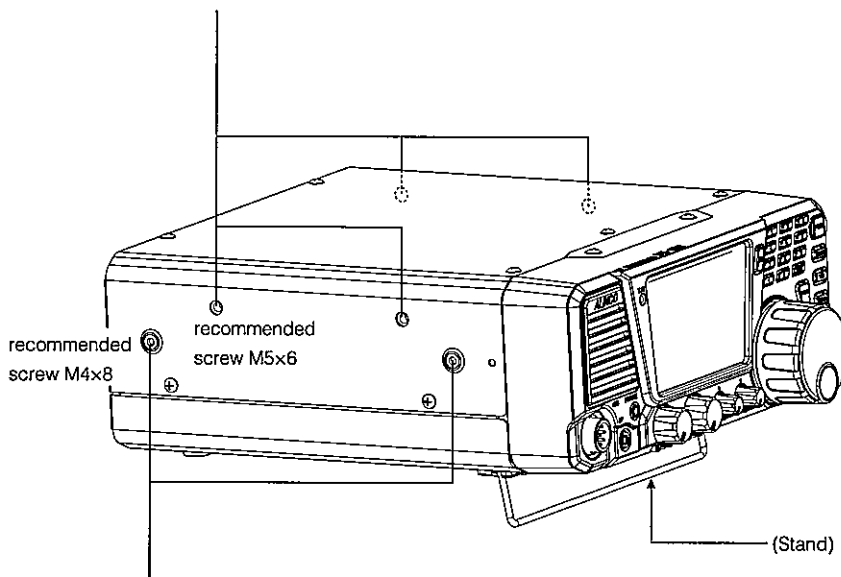

Screw holes for a carrying handle

Use a third-party handle for your convenience.

# **After-Sales Customer Services**

## **■ Warranty certificate:**

Please read the warranty policy declared on the certificate and follow the instruction if necessary. In case it's not validated, please keep the receipt as an evidence of your purchase with the certificate. Please be advised that the warranty certificates are provided by the authorized importer of your area, not by Alinco.

## **■ Warranty period:**

It may depend on the condition of purchase you agreed with the dealer. Please be sure to consult with the dealer about details of warranty-services policies before you purchase the product.

## **■ Repairs and other customer-service information:**

Please contact your dealer for details, or visit our website at [alinco.com](http://alinco.com).

## **■ About older products:**

We keep inventories of spare parts and minimum necessary accessories for at least 5 years since the product is discontinued.

However, please understand that unpredicted circumstances such as loss of stocks by natural disasters, part-suppliers related issues etc may cause troubles to offer such services to customers.

# Specifications

General	DX-R8	
Reception frequency range (MHz)	T : 150KHz to 29.99999MHz E : 150KHz to 34.99999MHz	
Memory channels	600 channels	
Receiving wave modes	J3E(USB, LSB), A3E(AM), A1A (CW), F3E(FM)	
Antenna impedance	50 $\Omega$	
Frequency stability	$\pm 1$ ppm	
Power supply voltage	13.8 V DC $\pm 15\%$ (11.7 to 15.8 V)	
Ground method	Negative ground	
Current drain	1.0 A (max.) 0.7 A (squelched)	
Operating temperature	-10°C to 60°C (+14°F to +140°F)	
Dimensions	240 (w) $\times$ 94 (h) $\times$ 255 (d) mm (excluding protrusions) (9.45" (w) $\times$ 3.7" (h) $\times$ 10" (d)) 240 (w) $\times$ 100 (h) $\times$ 293 (d) mm (9.45" (w) $\times$ 3.94" (h) $\times$ 11.54" (d))	
Weight	Approx. 4.1 kg	
Receiver type	Double superheterodyne	
Reception sensitivity	SSB	(0.15 to 1.8 MHz) 0 dBu (1 $\mu$ V)
	CW	(1.8 to 30 MHz) -12 dBu (0.25 $\mu$ V)
	AM	(0.15 to 1.8 MHz) +20 dBu (10 $\mu$ V) (1.8 to 30 MHz) +6 dBu (2 $\mu$ V)
	FM	(28 to 30 MHz) -6 dBu (0.5 $\mu$ V)
First mid-frequency	71.75 MHz	
Second mid-frequency	455 kHz	
Selectivity	SSB, CW, AM(narrow)	2.4 kHz/-6 dB 4.5 kHz/-60 dB
	AM, FM	6 kHz/-6 dB 18 kHz/-60 dB
Spurious rejection ratio	More than 70 dB	
Low frequency output	More than 2.0 W (8 $\Omega$ , 10% THD)	
RIT variable range	$\pm 1.2$ kHz	

All specifications are subject to change, with technological developments, without any notice.



# **ALINCO,INC.**

Head Office: Yodoyabashi-Dai Building 13th Floor  
4-9, 4-Chome, Koraihashi, Chuo-ku, Osaka 541-0043, Japan  
Phone: +81-6-7636-2362 Fax: +81-6-6208-3802  
<http://www.alinco.com/>  
E-mail: [export@alinco.co.jp](mailto:export@alinco.co.jp)